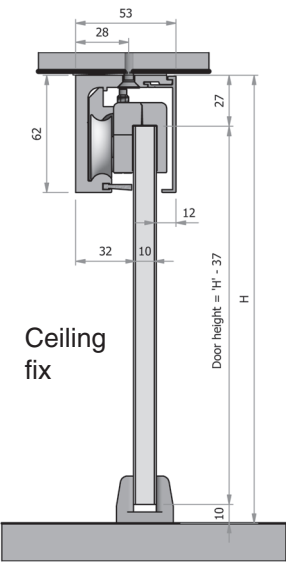
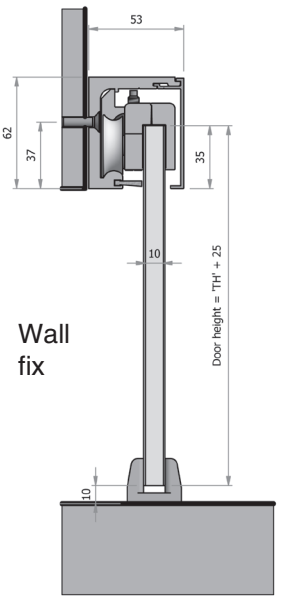

SECTION 4: SPECIALITY FRAMELESS DOOR SYSTEMS INDEX

Product	Page
Glass Glide Ceiling or Wall Mount	4.1 - 4.2
Glass Glide Ceiling Mount with Sidelight Carrier	4.3 - 4.4
MF250 Heavy Duty Top Hung Sets	4.5
Sienna SN120 Tubular Sliding Door System	4.6
Linear 100 Bottom Sliding Door System	4.7
Glaslide Bottom Sliding Multi Door External System	4.8 - 4.11

SPECIALITY FRAMELESS DOOR SYSTEMS

Glass Glide Sliding Door Set

Product	Code	Description	Per Set
 <p>Ceiling fix</p>		<p>FEATURES Slim profile track Top hung system Suitable for ceiling or wall fix installations No glass cutout required Specify 10mm or 12mm glass thickness Finish natural anodised</p> <p>Each set contains Track, Pelmet, Hangers, Stops, End Caps & Floor guides</p> <p>Maximum door weight 150kg</p>	
 <p>Wall fix</p>	GG.CW2000	DOOR SET To suit door up to 1000mm wide	
	GG.CW3000	DOOR SET To suit door up to 1500mm wide	
	GG.CW5000	DOOR SET To suit door up to 2500mm wide	
	GG.DK	KIT FOR ADDITIONAL DOOR Includes hangers, stops and guides	
Please note always specify glass thickness when ordering			

SPECIALITY FRAMELESS DOOR SYSTEMS

Glass Glide Sliding Door Setout Details

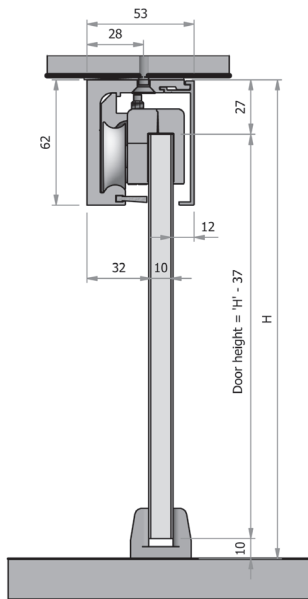

Ceiling fix
To determine door height
H = Overall opening height
DH = Glass door height
DH = H less 37mm

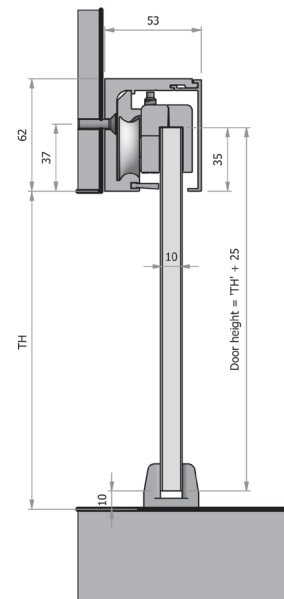

Wall fix
To determine door height
TH = Opening height to underside of transom
DH = Glass door height
DH = TH plus 25mm

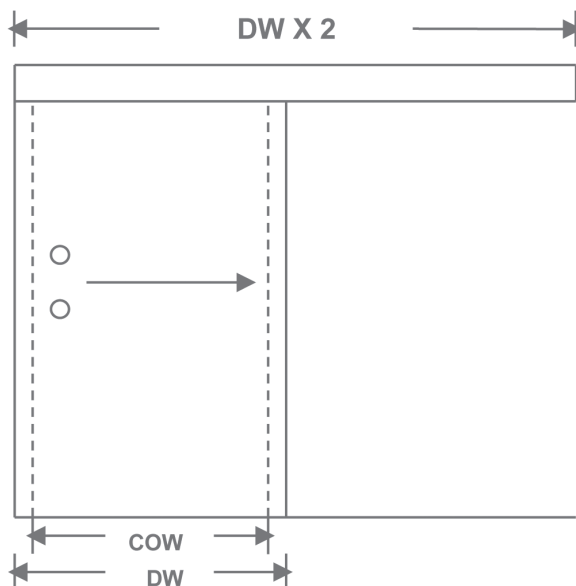

To determine door width
COW = Clear opening width
DW = Door width
Doors typically overlap the clear opening by 35mm each side
Eg. DW = COW + 70mm
Track length is 2 x door width

SPECIALITY FRAMELESS DOOR SYSTEMS

Glass Glide Ceiling Mount with Sidelight Carrier

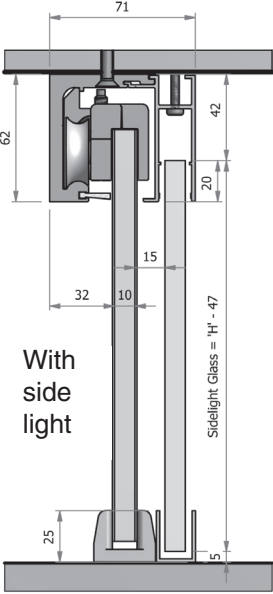
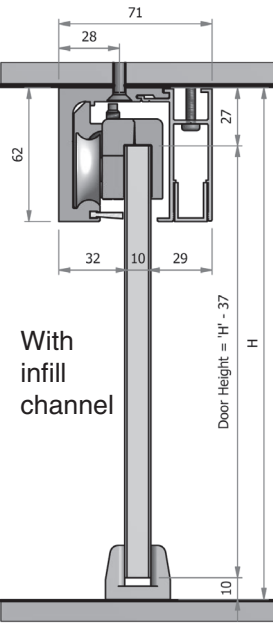
Product	Code	Description	Per Set
 <p>With side light</p>		<p>FEATURES Slim profile track with sidelight carrier section Top hung system Suitable for ceiling fix installations No glass cutout required Specify 10mm or 12mm glass thickness Natural anodised finish</p> <p>Each set contains Track, Sidelight carrier section, Infill channel for carrier Hangers, Stops, End Caps & Floor guides</p> <p>Maximum door weight 150kg</p>	
 <p>With infill channel</p>	GG.SP2000	DOOR SET To suit opening up to 2000mm wide (Door & sidelight)	
	GG.SP3000	DOOR SET To suit opening up to 3000mm wide (Door & sidelight)	
	GG.SP5000	DOOR SET To suit opening up to 5000mm wide (Door & sidelight)	
	GG.DK	KIT FOR ADDITIONAL DOOR Including hangers, stops and guides	
Please note always specify glass thickness when ordering			

SPECIALITY FRAMELESS DOOR SYSTEMS

Glass Glide Ceiling Mount with Sidelight Carrier

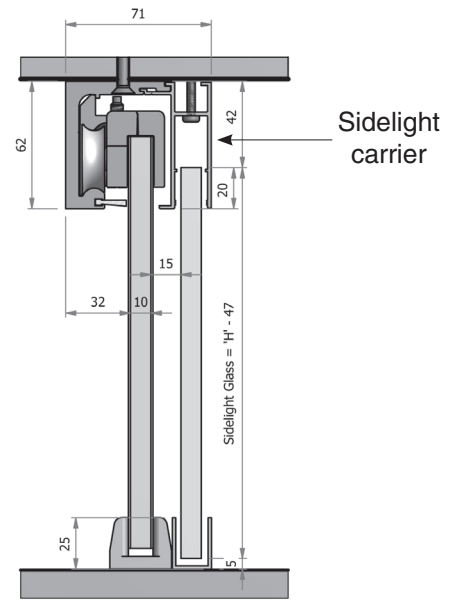
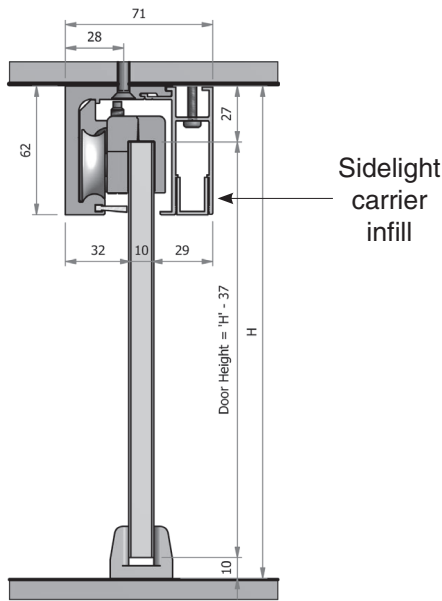

To determine the height of glass doors & sidelights

H = Overall opening height
DH = Glass door height
DH = H less 37mm

SL = Glass sidelight height
SL = H less 47mm

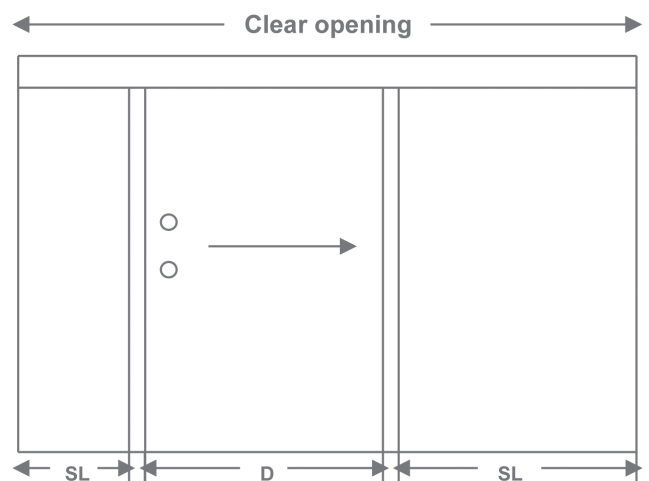
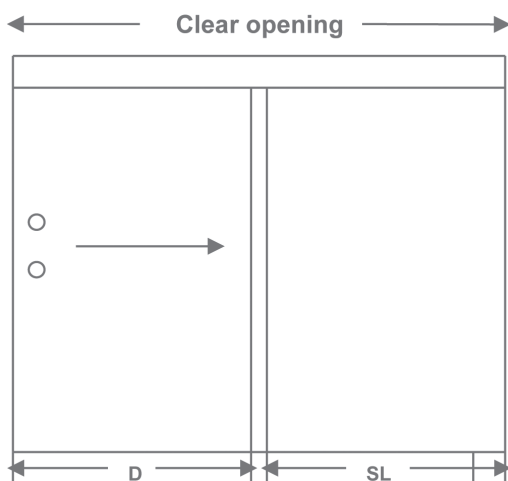

With the Glass Glide sliding door & sidelight system there are numerous set out options.

Above are two of the more common options.

Note: It is recommended that the door and sidelight overlap be 35mm each side.

When glazing side lights specify CS25 channel.

SPECIALITY FRAMELESS DOOR SYSTEMS

MF250 Sliding Door System

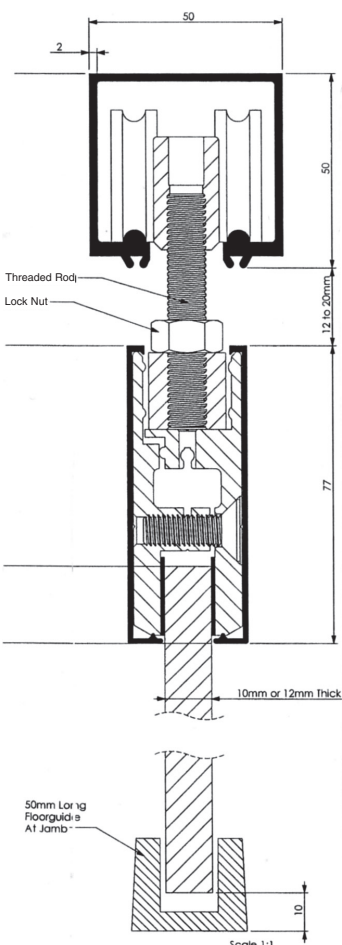
Product	Code	Description	Per Set
		TOP HUNG SYSTEM WITH STANDARD TOP RAIL No cutout in glass required Max door weight 250kg Each door kit contains: 1 x top track natural anodised 1 x top rail natural anodised 2 x hangers 2 x track steps 1 x floor guide Specify 10mm or 12mm glass thickness Finish natural anodised	
	MF250-1000	DOOR KIT For one door up to 1000mm wide All components as above Track 2000mm	
	MF250-1500	DOOR KIT For one door up to 1500mm wide All components as above Track 3000mm	
	MF250-2000	DOOR KIT For one door up to 2000mm wide All components as above Track 4000mm	
	MF250-000	CUSTOM DOOR SET	
	MF250-T50	ADDITIONAL TRACK Per metre	
	Note	System can be used in single, biparting and multiple lines of sliding doors. Bottom Rails and in ground channel guide systems available on request.	

SPECIALITY FRAMELESS DOOR SYSTEMS

Sienna SN120 Tubular Sliding Door Set

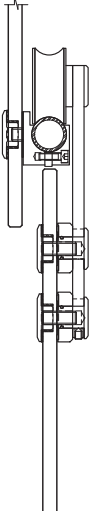
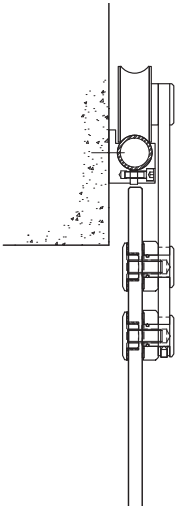
Product	Code	Description	Per Set
<p>Glass Mount</p>  <p>Solid Wall Mount</p> 		<p>Tubular top hung sliding door system supplied as single door sets. Two sets can be joined for biparting door applications.</p> <p>All components satin stainless steel finish.</p> <p>Sets include track, hangers, mounting brackets, stops and floorguide.</p> <p>Max door weight 120kg</p> <p>Max door width 1500mm</p> <p>Max door height 2400mm</p> <p>Glass thickness 10mm</p>	
		<p>GLASS MOUNT SETS</p> <p>Glass mount sets contain mount brackets to fix track to glass over light and side panels.</p>	
	SNGG25	<p>Glass mount set to suit up to 1250mm wide door. 2500mm track includes 7 glass mount brackets.</p>	
	SNGG30	<p>Glass mount set to suit up to 1500mm wide door. 3000mm track includes 7 glass mount brackets.</p>	
		<p>SOLID WALL MOUNT SETS</p> <p>Solid wall mount sets contain mount brackets to fix track to solid timber/concrete walls.</p>	
	SNGW25	<p>Wall mount set to suit up to 1250mm wide door. 2500mm track includes 5 wall mount brackets.</p>	
	SNGW30	<p>Wall mount set to suit up to 1500mm wide door. 3000mm track includes 6 wall mount brackets.</p>	
SNTJ10	<p>TRACK JOINTER</p>		

Setout details for all installation types available on request.

SPECIALITY FRAMELESS DOOR SYSTEMS

Linear 100 Sliding Door System

Specify 10mm or 12mm glass thickness

Product	Code	Description	Per Set
<p>Typical Glass Set Out</p>		BOTTOM ROLLING SLIDING DOOR SYSTEM FLOOR/CEILING FIX Max door weight 210kg Each door kit contains: 2 x 100 wheels satin stainless steel 2 x top channel stops 1 x top channel natural anodised 1 x bottom channel natural anodised	
	L100-1000	DOOR KIT For one door up to 1000m wide all components as above Track & Channel 2000mm	
	L100-1500	DOOR KIT For one door up to 1500m wide All components as above Track & Channel 3000mm	
	L100-2000	DOOR KIT For one door up to 2000m wide All components as above Track & Channel 4000mm	
		Components	Per Metre
	L153-T40	ADDITIONAL BOTTOM TRACK	
	L153-C50	ADDITIONAL TOP CHANNEL	
		System can be used with multiple lines of track for several doors opening in the same direction and biparting applications	

X = height of door which is finished opening height less 35mm
 Note: Allow for selected handle glass preparation

SPECIALITY FRAMELESS DOOR SYSTEMS





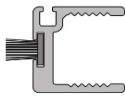
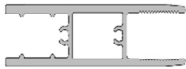
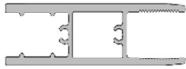
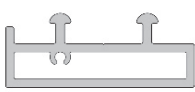
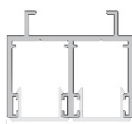
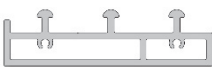
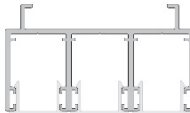

Glaslide Multi Sliding External Door Components

Request the Glaslide technical brochure for specifications and product details to ensure you order the correct components for your project.

Product	Code	Description	Price
	JGS/5211/5.8/PC	GLASLIDE INFILL CLIP 5800mm	
	JGS/5215/5.8/PC	GLASLIDE CLOSING STILE Without woodpile 5800mm	
	JGS/5216M/1400/PC	GLASLIDE BOTTOM MACHINED For magnetic latch Max. door width 1100mm	
	JGS/5216/5.8/PC	GLASLIDE BOTTOM RAIL 5800mm	
	JGS/5217/5.8/PC	GLASLIDE DOUBLE BOTTOM TRACK 5800mm	
	JGS/5218/5.8/PC	GLASLIDE DOUBLE TOP TRACK 5800mm	
	JGS/5227/5.8/PC	GLASLIDE TRIPLE BOTTOM TRACK 5800mm	
	JGS/5228/5.8/PC	GLASLIDE TRIPLE TOP TRACK 5800mm	



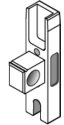
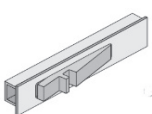

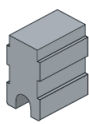

SPECIALITY FRAMELESS DOOR SYSTEMS

Glaslide Multi Sliding External Door Components

Product	Code	Description	Price
	JGS/W01/SS	GLASLIDE 60KG DUAL WHEEL ROLLER	
	JGS/C02/PL	GLASLIDE END CATCH CAP NON HANDED	
	JGS/C03/PC	GLASLIDE RAIL END CAP PLAIN	
	JGS/C04/12/PC	GLASLIDE RAIL END CAP 12MM NOTCH	
	JGS/C04/15/PC	GLASLIDE RAIL END CAP 15MM NOTCH	
	JGS/C05/PC	GLASLIDE RAIL MAGNET LATCH KEEPER NON HANDED	
	JGS/C01/PC	GLASLIDE MAGNETIC LATCH ASSEMBLY	
	JGS/C06/M	GLASLIDE CORNER CLEAT	
	JGS/C07/B	GLASLIDE RUBBER END DOOR STOP	
	JGS/C18	GLASLIDE WIND LOAD BLOCK	

SPECIALITY FRAMELESS DOOR SYSTEMS

Glaslide Multi Sliding External Door Components





Product	Code	Description	Price
	JGS/C08	GLASLIDE CLEAR DOME TOP BUMP – SHEET OF 45	
	JGS/C09/BLACK	GLASLIDE RUBBER CAP BUMP	
	JGS/C10	GLASLIDE 10MM GLAZING CLIP 150MM BLACK	
	JGS/C12	GLASLIDE 12MM GLAZING CLIP	
	JGS/C15	GLASLIDE 15MM SETTING BLOCK	
	JC225/350/BLACK	7MM HIGH WOOL PILE Black per metre	
<p>Note. All powder coat colours are to order. If orders are under 20 lineal metres of product, a short run powder coat charge will apply. Non standard colours from the Juralco colour range will have a surcharge. Mill products are less 10% off the powder coat price list. For standard powder coat colours, refer to page 4.13.</p>			

SPECIALITY FRAMELESS DOOR SYSTEMS



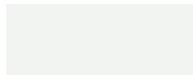
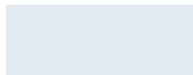
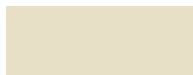



STANDARD POWDER COAT COLOURS



WHITE

	MATT APPLIANCE WHITE 9151274M
	ARCTIC WHITE 91558851
	OFF WHITE 91558804
	PEARL WHITE 28897434
	MATT RIVERGUM BEIGE 9153143M
	MATT WOODWIND 9153155M





BROWN

	MATT BRONCO 9152111M
	MATT DESERT SAND 9153065M
	MATT IRONSAND 9158096M
	MATT KAURI 9158159M
	MATT LIGNITE 9158033M
	MATT OLIVE 9156193M

BLUE

	MATT NEW DENIM BLUE 9155063M
--	--





GREEN

	MATT KARAKA 9156064M
	MATT LICHEN 9156101M
	MATT MIST GREEN 9156103M
	MATT PERMANENT GREEN 9156102M







LIGHT GREY

	MATT CANVAS CLOTH 9157327M
	MATT GHOST GREY 9157401M
	MATT GULL GREY 9157511M
	MATT O'KEEFE GREY 9157400M
	LSG MATT TITANIA 9152068M

METROPOLIS (KINETIC)

	BRONZE FROST KINETIC 9008194K
	SILVER FROST KINETIC 9157323K
	SILVER PEARL METROPOLIS KINETIC 9157113K
	SILVER STAR METROPOLIS KINETIC 9157043K
	WINDOW BRONZE METROPOLIS KINETIC 9158068K

BLACK

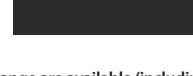
	MATT BLACK 9159041M
	MATT CHARCOAL 9159058M
	MATT FLAX POD 9159145M
	MATT GRAVEL 9157404M
	MATT GREY FRIARS 9157167M
	MATT SANDSTONE GREY 9157217M
	SATIN BLACK 91558651

RED

	MATT SCORIA 9154114M
---	--------------------------------

ANOTEC

	ANOTEC MID BRONZE 91558751
---	--------------------------------------

Other powder coat colours from the Interpon Standard, Dulux Duralloy or Dulux Metropolis Pearls Powder coat range are available (including Satin rather than Matt Finishes), however please note that they incur a surcharge. Please contact Juralco with any queries.

These colours are representative only, please take the time to check an actual powder coated sample of the colour of your choice