

SECTION 3: COMMERCIAL HARDWARE





INDEX

Product	Page
Standard Patch Fittings	3.1 - 3.2
Standard Patch Fitting Components	3.3
XL Patch Fittings for 15-19mm Glass	3.4
Door Rails and Components	3.5
Ozone Self Closing Hydraulic Patch FH100	3.6 - 3.7
Ozone High Strength Hydraulic Patch FH105	3.8 - 3.9
Platinum Floor Springs & Components	3.10
Dorma Floor Springs & Transom Closer	3.11
Laguna Hydraulic Door Hinges	3.12 - 3.13
Pull Handles	3.14 - 3.15
Lever Locks or Latchsets	3.16
Door Seals	3.17 - 3.18
Channel Sections	3.19 - 3.21

FRAMELESS COMMERCIAL HARDWARE

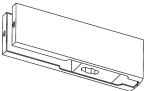
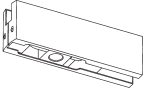
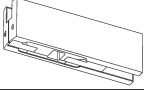
Patch Fittings

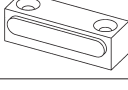
Specify 10mm or 12mm glass thickness

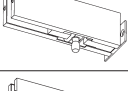
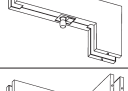
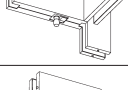
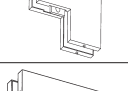
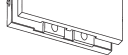
Product	Code	Description	SSS & PSS	Matt Black P/C
	PF10	BOTTOM PATCH FITTING		
	PF20	TOP PATCH FITTING		
	PF22	TOP PATCH FITTING For overhead transom closer		
	PF24	TOP PIVOT With plate mounting		
	PF25	TOP PIVOT 22mm Long Pin With M8 threaded rod, washer and nut. All SSS		
	PF26	STANDARD FLOOR PIVOT		
	PF28	TRANSOM MOUNT STOP Single door 50mm		
	PF32	FLOOR MOUNT STOP		
	PF33	WALL MOUNT STOP 76mm projection. Concealed fixings.		
	PF34	OVERPANEL TO WALL PATCH FITTING		
	PF40	OVERPANEL TO SIDE PANEL PATCH FITTING		
	PF41	OVERPANEL TO SIDE PANEL With fin mounting patch fitting		
	PF61	OVERPANEL TO SIDE PANEL PATCH FITTING with optional stop		
	PF70	OVERPANEL PATCH FITTING With two optional stops to suit double doors		

FRAMELESS COMMERCIAL HARDWARE

Patch Locks

Specify 10mm or 12mm glass thickness

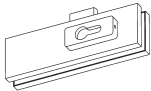
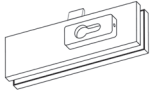
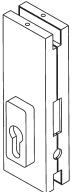
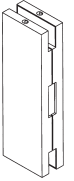
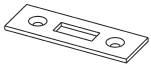
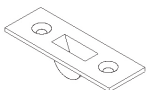
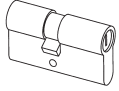
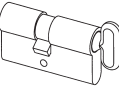
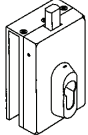
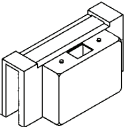
Product	Code	Description	SSS & PSS	Matt Black P/C
	PF100-T	BOTTOM PATCH TOUGH LOCK Includes cylinders and keeper		
	PF100-P	BOTTOM PATCH PIN LOCK Includes cylinders and keeper		
	PF200	CENTRE PATCH LOCK Includes cylinders For locks specify cylinder type DC - Double Cylinders CT - Cylinder Turn		
	PF220	CENTRE PATCH KEEPER		
	PK240	TOUGH LOCK KEEPER For transom, mullion or ground installations		
	PK250	PIN LOCK KEEPER For transom, mullion or ground installations		
	DC110	DOUBLE CYLINDERS (Euro type)		
	CT110	CYLINDER AND TURN (Euro type)		
	PF300	SPECIAL SLIDE-ON PATCH LOCK No glass cut-out required Suitable for 10mm and 12mm glass Complete with single sided key cylinder		
	PF330	SLIDE-ON PATCH LOCK KEEPER For side panel Use with PF300 lock		

FRAMELESS COMMERCIAL HARDWARE

Patch Fitting Components

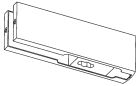
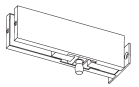
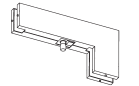
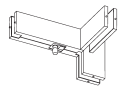
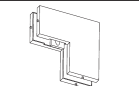
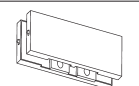
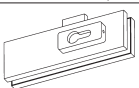
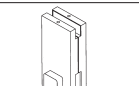
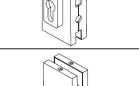
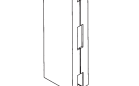
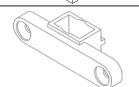
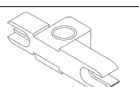
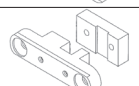
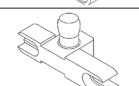
Product	Code	Description	S/Steel Polished or Satin	Forging
	CP10	COVER PLATE SET To suit PF10, PF20 & PF22 patch fitting		
	CP34	COVER PLATE SET To suit PF34 patch fitting		
	CP40	COVER PLATE SET To suit PF40 patch fitting		
	CP41	COVER PLATE SET To suit PF41 patch fitting		
	CP61	COVER PLATE SET To suit PF61 patch fitting		
	CP70	COVER PLATE SET To suit PF70 patch fitting		
	CP100	COVER PLATE SET To suit PF100 bottom patch lock		
	CP200	COVER PLATE SET To suit PF200 centre patch lock		
	CP220	COVER PLATE SET To suit PF220 centre lock keeper		
	IS10	INSERT AND SCREWS To suit PF10 patch fitting		
	IS20	INSERT AND SCREWS To suit PF20 patch fitting		
	IS22	INSERT AND SCREWS To suit PF22 patch fitting		
	IS40	INSERT AND SCREWS To suit PF34, PF40 & PF41 patch fittings		
	IS41	INSERT STOP To suit PF34, PF40 AND PF41 patch fittings		
	IS61	INSERT STOP To suit PF61 patch fitting		

FRAMELESS COMMERCIAL HARDWARE

XL Patch Fittings

For 15mm or 19mm glass

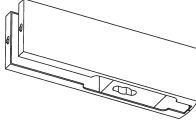
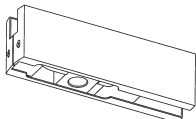
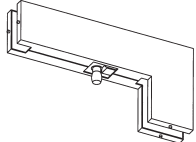
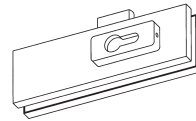
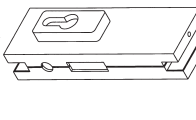
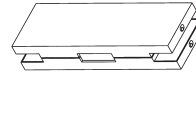



Product	Code	Description	SSS
	XL10	BOTTOM PATCH FITTING Thickness 40mm	
	XL20	TOP PATCH FITTING Thickness 40mm	
	XL40	OVER PANEL TO SIDE PANEL PATCH FITTING Thickness 41.5mm	
	XL100	BOTTOM PATCH LOCK Includes keeper and cylinder turn Thickness 38mm	
	XL200	CENTRE PATCH LOCK Includes cylinder turn Thickness 38mm	
	XL220	CENTRE PATCH KEEPER Thickness 38mm	

NOTE: Request cut out drawings before glass manufacture.

FRAMELESS COMMERCIAL HARDWARE

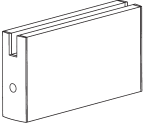
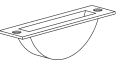
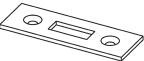
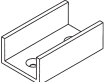
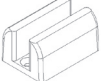
Door Rails and Componentry

Specify 10mm or 12mm glass thickness

Product	Code	Description	Natural Silver Anodised	S/Steel Polished or Satin	
		Rails up to 1000mm length	Minimum charge 1 metre		
	MR10	BOTTOM PIVOTING RAIL Non locking			
	MR20*	TOP PIVOTING RAIL Non locking			
	MR30	BOTTOM PIVOTING RAIL Locking			
	MR40*	TOP PIVOTING RAIL Locking			
	MR50	BOTTOM SLIDING RAIL Non locking			
	MR60	TOP SLIDING RAIL Non locking			
	MR70	BOTTOM SLIDING RAIL Locking			
	MR80	SIDE PANEL RAIL			
			*Extra for RTS85 Insert		
			Rails over 1000mm long Extra per 1mm		
Locking rails are supplied with a cylinder and turn as standard					
	MK590	590 GROUND KEEPER SSS			
	KP590	590 FLAT PLATE KEEPER SSS			
	MRG	FLOOR GUIDE FOR SLIDING RAILS Black Nylon			
	MDG	FLOOR GUIDE FOR GLASS DOORS SCP Adjustable to suit glass from 8mm to 12mm			
	MSC90	SINGLE CYLINDER includes screw pack			
	MTK90	TURN KNOB includes screw pack			
	MER90	ESCUTCHEON ROSE			

FRAMELESS COMMERCIAL HARDWARE

Ozone Self Closing STD Strength Hydraulic Patch EN3

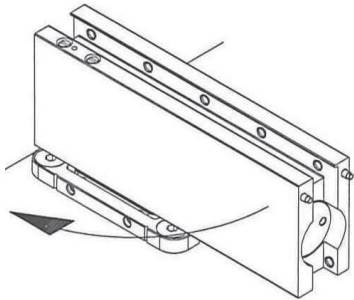
Product	Code	Description	SSS & PSS	Matt Black
	FH-100 HO	Ozone Self Closing Hydraulic Patch 90° HOLD OPEN		
	FH-100 NHO	Ozone Self Closing Hydraulic Patch NON HOLD OPEN		

Self closing floor mounted patch fitting for internal Frameless Glass doors up to 1000mm wide.

Simple installation with four screw fixings into any floor. Adjustable base plate for easy alignment of the door in either direction shown in diagram below.

Suitable for double action doors. Used in conjunction with standard PF20 top patch fitting. Two speed closing adjustment as shown below.

Suits toughened frameless glass doors from 8mm - 12mm thick with a maximum door weight of 100kg's.

Not recommended for use with Maglocks.

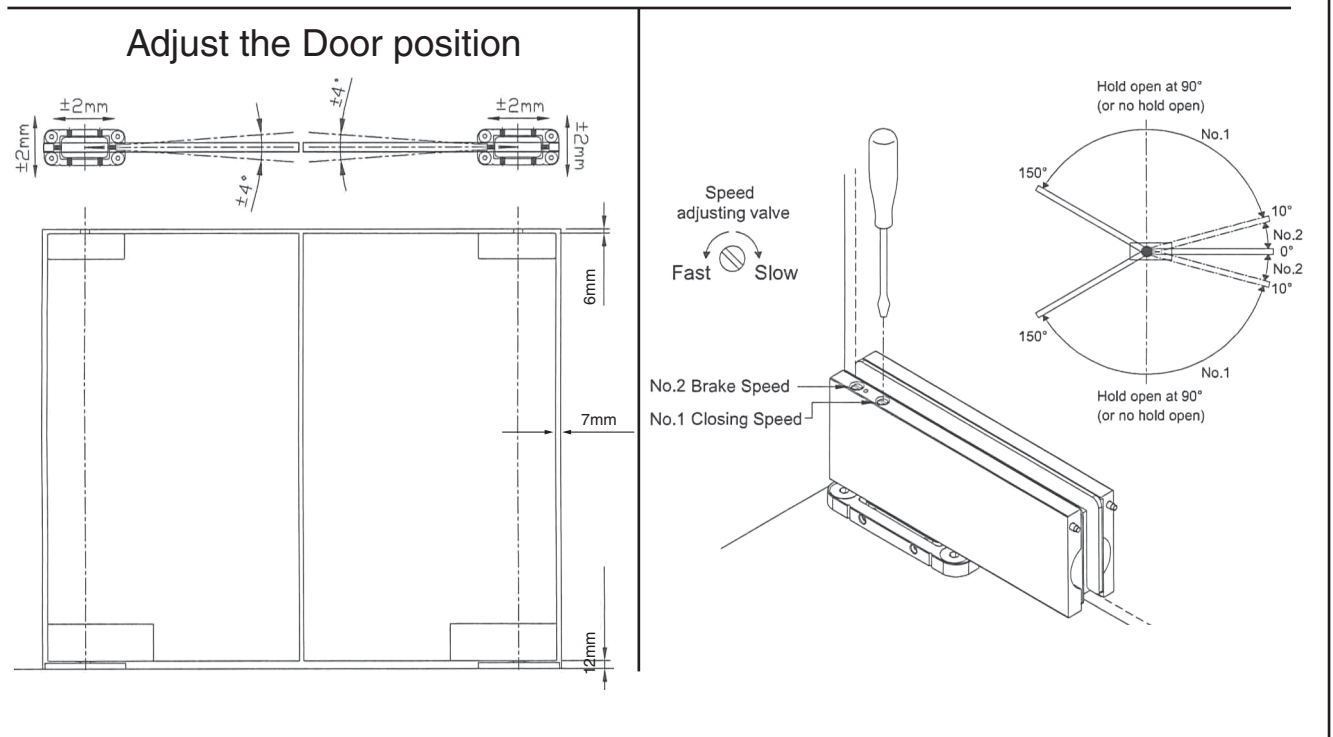

FRAMELESS COMMERCIAL HARDWARE

Ozone Self Closing STD Strength Hydraulic EN3 Patch Cutout & Installation

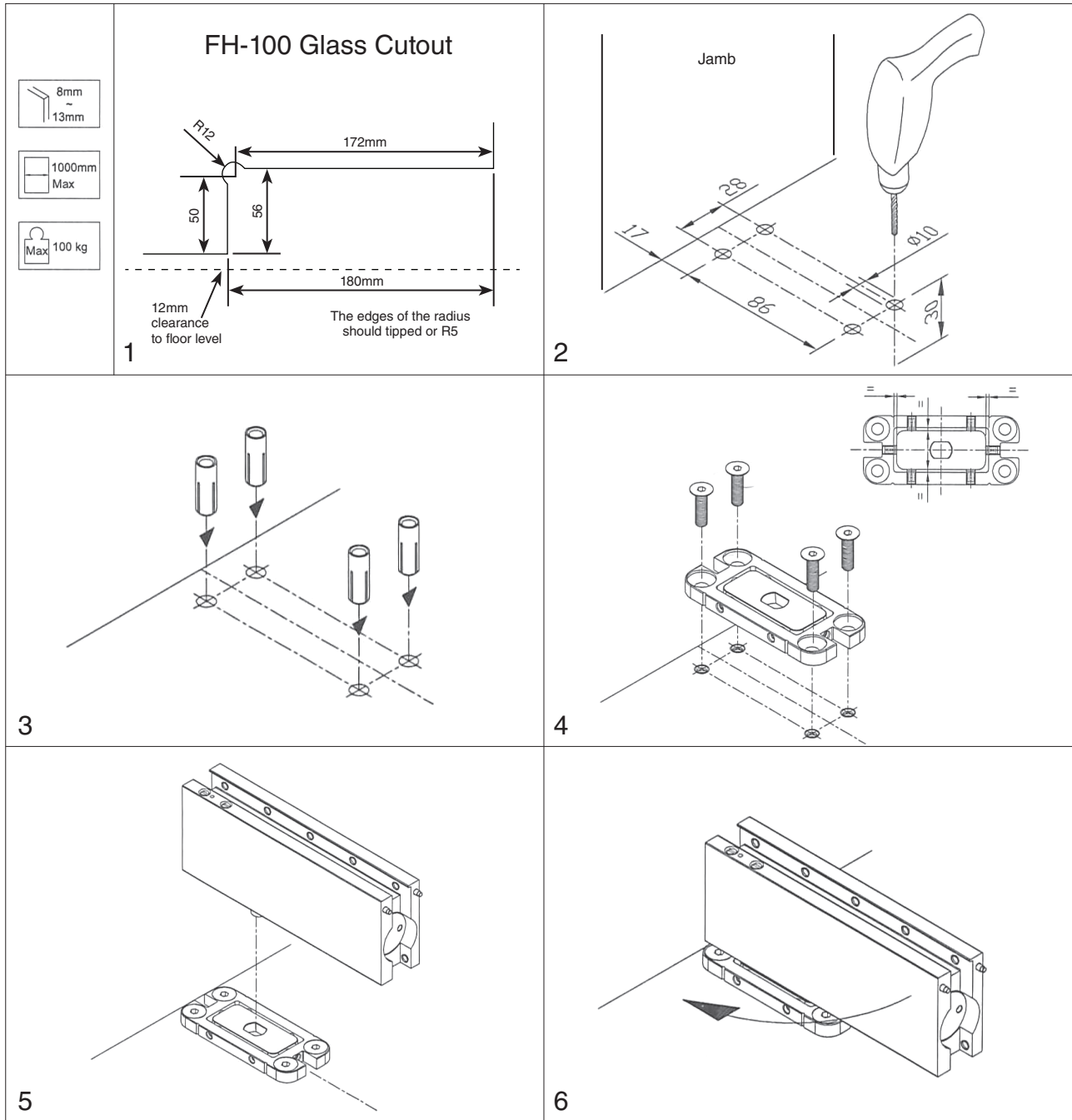

Once the patch is at 90° to the base the gaskets can be added and the door slid onto the patch and clamped in place by tightening up the screws on the side. The door speed and brake speed can then be adjusted to suit your requirements, then the cover caps clipped in place to complete the installation.

FRAMELESS COMMERCIAL HARDWARE

Ozone HS - High Strength Hydraulic Patch Fitting EN5

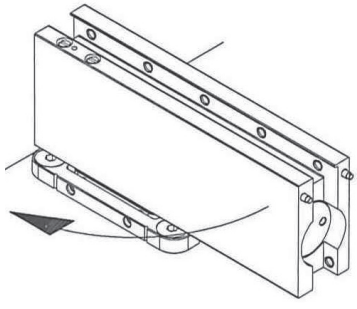
Product	Code	Description	SSS & PSS	Matt Black
	FH-105 HO	Ozone High Strength Hydraulic Self Closing Patch 90° HOLD OPEN		
	FH-105 NHO	Ozone High Strength Hydraulic Self Closing Patch NON HOLD OPEN		

FH-105 Ozone high strength floor mounted patch fitting suitable for both internal and external doors.

Internal door max width = 1250mm External door max width = 1000mm

Simple installation with four screw fixings into any floor. Adjustable base plate for easy alignment of the door in either direction shown in diagram below.

Suitable for double action doors. Used in conjunction with standard PF20 top patch fitting. Two speed closing adjustment as shown below.

Suits toughened frameless glass doors from 10mm – 15mm thick with a maximum door weight of 100kg's.

Not recommended for use with Maglocks.

Ozone Base Plate Packers

Product	Code	Description	SS
	FH-3	3mm base plate packer Increases ozone ground Clearance to 15mm	
	FH-5	5mm base plate packer Increases ozone ground Clearance to 17mm	
	FH-10	10mm base plate packer Increases ozone ground Clearance to 22mm	

FRAMELESS COMMERCIAL HARDWARE

Ozone High Strength Hydraulic Patch Cutout and Installation EN5

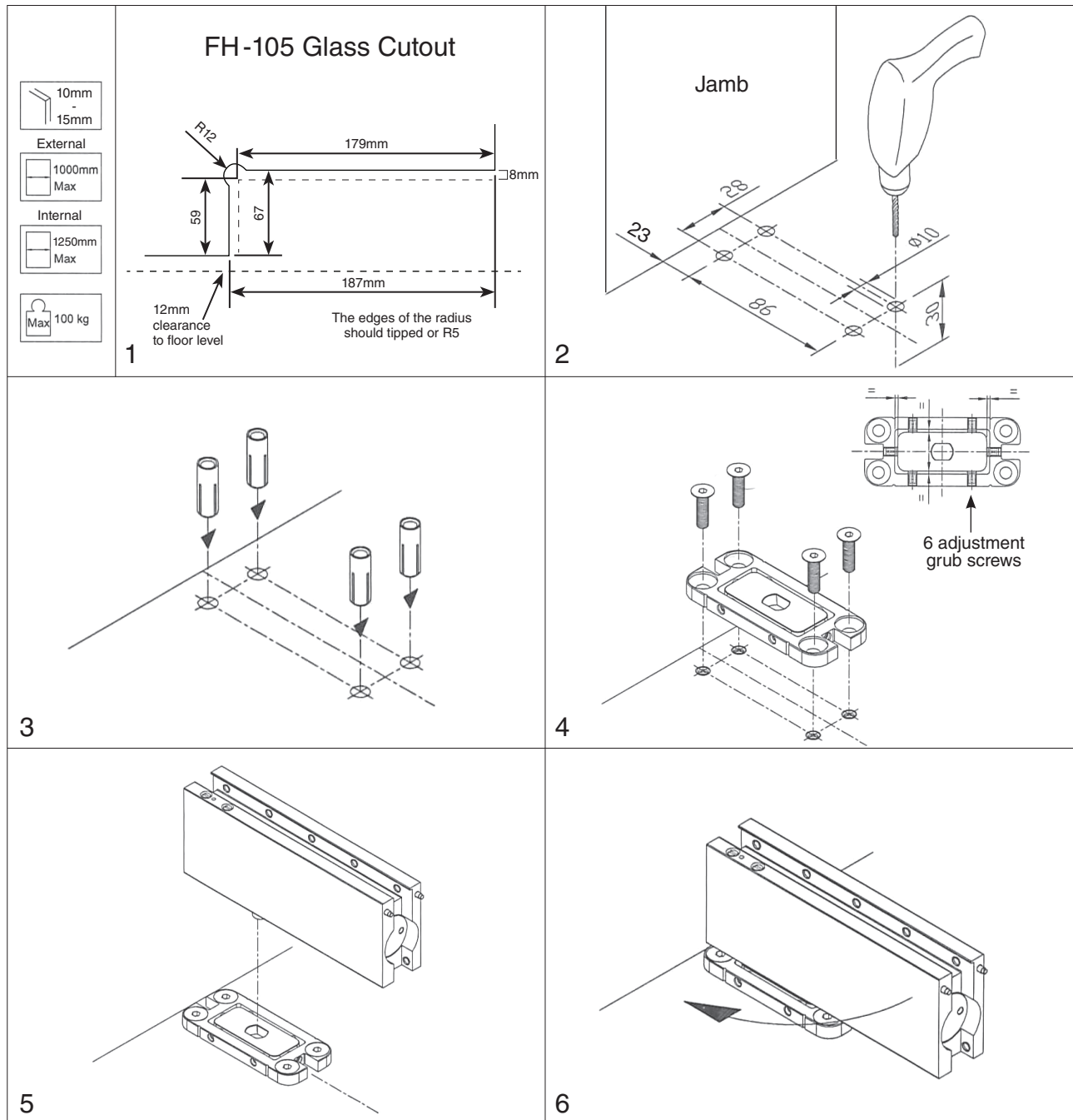

Once the patch is at 90° to the base the gaskets can be added and the door slid onto the patch and clamped in place by tightening up the screws on the side. The door speed and brake speed can then be adjusted to suit your requirements, then the cover caps clipped in place to complete the installation.

FRAMELESS COMMERCIAL HARDWARE

Platinum Floor Springs

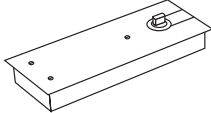

Product	Code	Description	Price
		FSX-840 SERIES Designed to be used with Platinum patch fittings and door rails Supplied complete with floor box & SSS cover plate Floor box dimensions 307mm long x 108 wide x 40mm deep Maximum door width 1100mm Maximum door weight 100kg Floor clearance height for patch fittings 12mm	
		FLOOR SPRINGS WITH REMOVABLE SPINDLES Supplied with standard height spindles	
	FSX-840W-NHO	Weak Strength 15NM Non Hold Open	
	FSX-840W-HO	Weak Strength 15NM Hold Open 90°	
	FSX-840S-NHO	Standard Strength 25NM Non Hold Open	
	FSX-840S-HO	Standard Strength 25NM Hold Open 90°	
		EXTENDED SPINDLES TO SUIT FLOOR SPRINGS Extended by 5mm	
	FS X-5	Extended by 5mm	
	FS X-10	Extended by 10mm	
	FS X-15	Extended by 15mm	
FS X-20	Extended by 20mm		
FS X-25	Extended by 25mm		

FRAMELESS COMMERCIAL HARDWARE

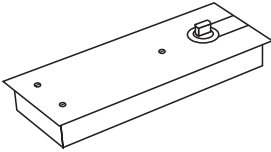
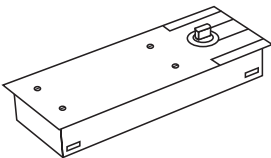
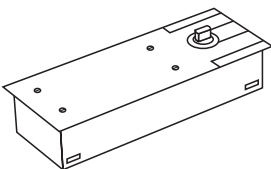
Dorma Floor Springs

Product	Code	Description	Price
	BTS84	LOW PROFILE FLOOR SPRING 40mm deep Complete with S/S cover and screw pack. Will carry doors up to 100kg. Max door width 1100mm.	
		NON HOLD OPEN 25NM standard strength	
		HOLD OPEN 90° 25NM standard strength	
		NON HOLD OPEN 15NM weak strength	
		HOLD OPEN 90° 15NM weak strength	
	BTS75	ADJUSTABLE STRENGTH FLOOR SPRING 50mm deep. Complete with S/S cover plate and screw pack. Will carry doors up to 120kg. Max door width 1100mm.	
		NON HOLD OPEN 15NM to 25NM strength	
		HOLD OPEN 90° 15NM to 25NM strength	
	BTS80	HEAVY DUTY FLOOR SPRING 60mm deep Will carry doors up to 300kg. Max door width 1400mm. Selectable hold open and non hold open.	
		35NM strength	
		53NM strength	

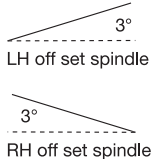
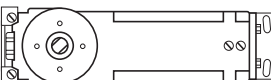
Dorma Accessories

Product	Code	Description	Price
		EXTENDED SPINDLES To suit all BTS Floor Springs	
		Standard height. Offset 3° for single action LH or RH	
		Extended by 5mm, 7.5mm or 10mm	
	RTS85	OVERHEAD TRANSOM CLOSER	
		NON HOLD OPEN 25NM Standard Strength	
		HOLD OPEN 90° 25NM Standard Strength	
		WF WOOD FIX COVER PLATE SSS AF ALUMINIUM FIX COVER PLATE SSS	
	2300	SEALING COMPOUND To protect floor spring from water damage Two pack mix	

FRAMELESS COMMERCIAL HARDWARE

Laguna Hydraulic Door Hinges

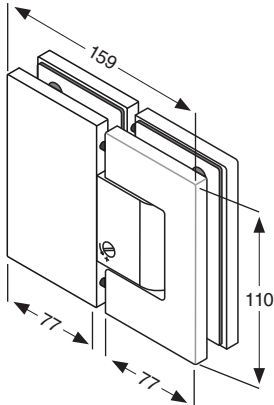
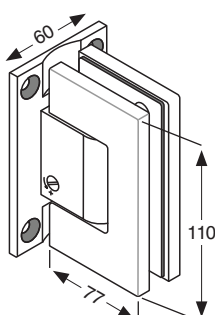
Product	Code	Description	Price Per Single Hinge	
		Double action hydraulic hinges with adjustable closing speed. Suitable for internal doors up to 900mm wide.	316 SSS	316 PSS
	LH-180 NHO SSS	Glass to Glass Non Hold Open SSS Suit 10mm & 12mm glass		
	LH-180 NHO-PSS	Glass to Glass Non Hold Open PSS Suits 10mm & 12mm glass		
	LH-180 HO-SSS	Glass to Glass 90° Hold Open SSS Suits 10mm & 12mm glass		
	LH-180 HO-PSS	Glass to Glass 90° Hold Open PSS Suits 10mm & 12mm glass Non stock item. Check lead time.		
Frameless door max weight 100kg = max width 1000mm hinges are non handed				
	LH-90 NHO-SSS	Wall to Glass Non Hold Open SSS Suits 10mm & 12mm glass		
	LH-90 NHO-PSS	Wall to Glass Non Hold Open PSS Suits 10mm & 12mm glass		
	LH-90 HO-SSS	Wall to Glass 90° Hold Open SSS Suits 10mm & 12mm glass		
	LH-90 HO-PSS	Wall to Glass 90° Hold Open PSS Suits 10mm & 12mm glass Non stock item. Check lead time.		
Suitable for internal doors double action doors up to 900mm, wide 80kg				

FRAMELESS COMMERCIAL HARDWARE

Laguna Hydraulic Door Hinges: Cut Out and installation details

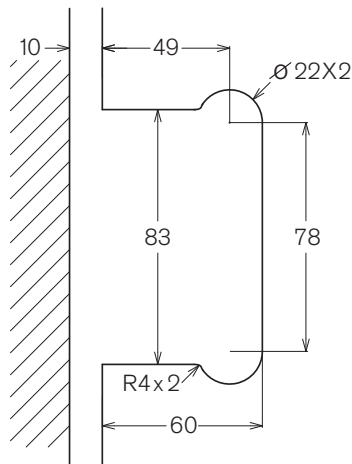

Wall to Glass Cut Out

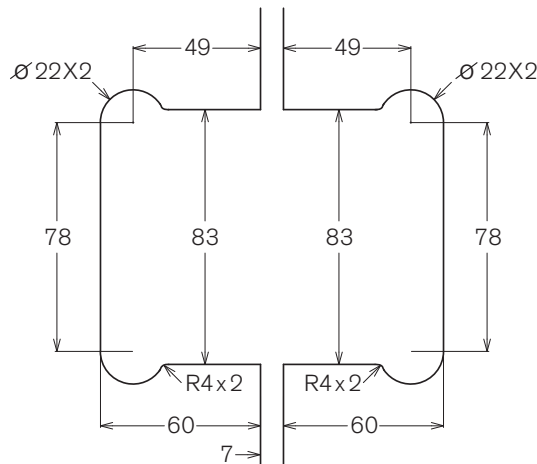

Glass to Glass Cut Out

Door alignment

1. Remove covers (E)
2. Loosen allen screws by 360° (D)
3. Adjust to required angle and retighten allen screws (D)
4. (C) is slotted speed valve.

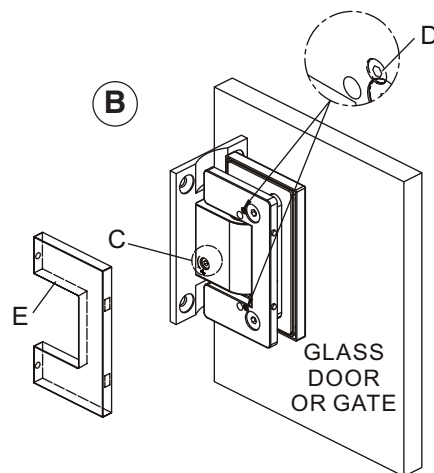
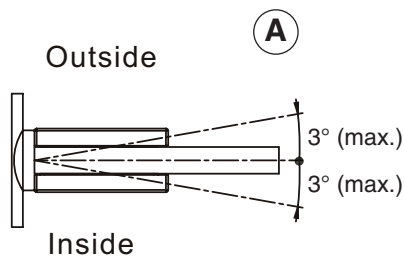

These self closing hydraulic door hinges are designed to close doors up to 900mm wide and 80kg in weight in internal installations.



Hinges available in (HO) Hold Open and (NHO) Non Hold Open. The hinges are available in both glass to glass and glass to wall models and both models are Non Handed, meaning they can be hung on either side of the opening.

Gaskets are provided so the glass door and side panels can be 10mm or 12mm toughened glass.

1. Remove clip on covers and install the hinges. Ensure all clearances are correct.
2. If door requires alignment, loosen allen keys on both hinges by 360° as per detail B. Set the door to correct alignment and retighten allen screws.
3. To set closing speed, close slotted screws on both hinges then open both ¼ of a turn. Then open or close slotted valves to obtain required closing speed. Take care to ensure the valves of each hinge are synchronized so they close at equal speed.
4. Install clip on covers.

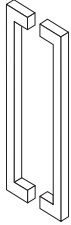
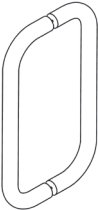

FRAMELESS COMMERCIAL HARDWARE

Pull Handles

Product	Code	Description	SSS	Matt Black
	SQD600	600mm x 25mm square profile handle 600mm C.T.C. Hole centres 600mm Hole diameters 12mm		
	MD300	D PULL HANDLE 300mm x 32mm diameter Hole centres 300mm, hole diameters 14mm.		
	MD500	500mm x 32mm diameter Hole centres 500mm, hole diameters 14mm.		
	MD600	600mm x 32mm diameter Hole centres 600mm, hole diameters 14mm.		
	MF600	FINELINE PULL HANDLE 600mm x 25mm diameter Hole centres 400mm Hole diameters 14mm		
	MF900	900mm x 25mm diameter Hole centres 700mm Hole diameters 14mm		
	SQ25-600	SQUARELINE PULL HANDLE 600mm x 25mm Square profile Hole centres 425mm Hole diameters 12mm		

FRAMELESS COMMERCIAL HARDWARE

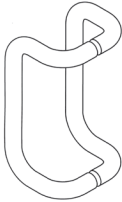
Pull Handles

Product	Code	Description	SSS
	MO300	OFFSET D HANDLE 300mm x 32mm diameter Hole centres 300mm Hole diameters 14mm	
	MB450	BOW HANDLE 450mm x 32mm diameter Hole centres 450mm Hole diameters 14mm	
	RA450 RA600	RECTANGULAR D PULL HANDLE 475mm x 50mm x 25mm handle 450mm C.T.C. 625mm x 50mm x 25mm handle 600mm C.T.C. Hole centres 450mm & 600mm Hole diameters 12mm	

Sliding Door Finger Pulls

Product	Code	Description	SSS
	FP50-10 FP50-12	SLIDING DOOR FINGER PULL Pull 50mm diameter Finish SSS Specify glass thickness 10mm or 12mm Glass cut out, 40mm diameter hole	

FRAMELESS COMMERCIAL HARDWARE

Lever Locks and Latch Sets

Specify 10mm or 12mm glass thickness

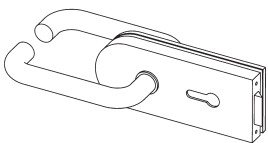
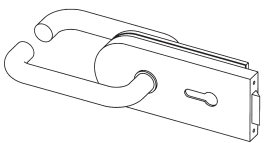
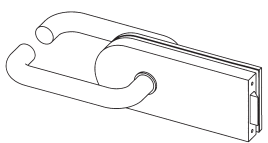
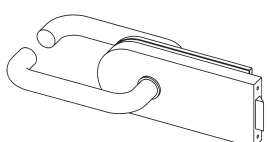
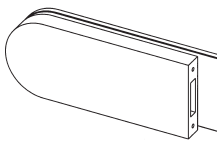
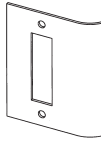
Product	Code	Description	Polished or Satin S/Steel
	LLJ-01	LEVER LOCKSET WITH CYLINDER Locking to timber or aluminium jamb	
	LLG-02	LEVER LOCKSET Locking to glass sidelight	
	LLJ-03	LEVER LATCHSET Latching to timber or aluminium jamb	
	LLG-04	LEVER LATCHSET Latching to glass sidelight	
	LSG-08	STRIKE BOX for glass sidelight	
	LSJ-09	STRIKE PLATE for aluminium or timber jambs	

GLASS PREPARATION DRAWING

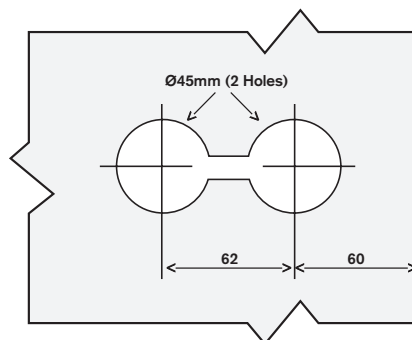

FRAMELESS COMMERCIAL HARDWARE

Door Seals and Components

PRICES PER LENGTH

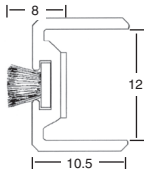
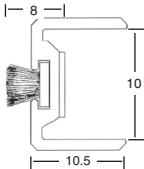
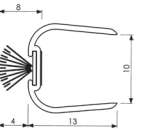
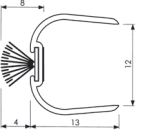
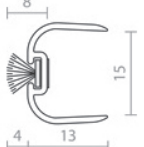
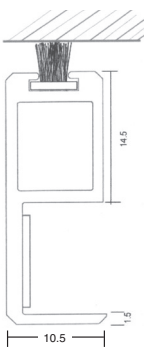
Product	Code	Description	Silver Anodised per length
	DS180-12	ANODISED ALUMINIUM SECTION With polypropylene grey pile Includes double sided adhesive foam tape For 12mm thick glass. Length 3000mm	
	DS180-10	ANODISED ALUMINIUM SECTION With polypropylene grey pile Includes double sided adhesive foam tape For 10mm thick glass. Length 3000mm	
			Clear Poly Per Length
	RP103	CLEAR POLYCARBONATE SECTION With black polypropylene pile. For 10mm thick glass. Length 3000mm	
	RP104	CLEAR POLYCARBONATE SECTION With polypropylene pile For 12mm thick glass Length 3000mm	
	RP42	CLEAR POLYCARBONATE SECTION With polypropylene pile For 15mm thick glass Length 3000mm	
	DSS90	SLIDING DOOR 90 DEGREE SEAL Anodised aluminium section with polypropylene grey pile. Includes double sided adhesive tape. Seal fitted to back edge of door to create seal back to side panel or wall. Profiles match DS180 seals. When ordering specify dimension 'Y'. See page 3.22 selection chart	Silver Anodised per length
	DSS90-12-Y	To suit 12mm glass 3000mm length	
	DSS90-10-Y	To suit 10mm glass 3000mm length	

FRAMELESS COMMERCIAL HARDWARE

This 90° Door Seal provides a seal between Frameless Glass Sliding door panels and sidelights or walls.

Selection Chart:

X = Glass thickness 10mm or 12mm
Y = Wool pile (just touches side panel)

For 10mm thick glass

X = 10mm Y = 18mm Order DSS90-10-18
 Y = 20mm Order DSS90-10-20
 Y = 23mm Order DSS90-10-23
 Y = 26mm Order DSS90-10-26
 Y = 28mm Order DSS90-10-28
 Y = 32mm Order DSS90-10-32

For 12mm thick glass

X = 12mm Y = 18mm Order DSS90-12-18
 Y = 20mm Order DSS90-12-20
 Y = 23mm Order DSS90-12-23
 Y = 26mm Order DSS90-12-26
 Y = 28mm Order DSS90-12-28
 Y = 32mm Order DSS90-12-32

Features:

- Suitable for manual or automatic doors
- Slim profile
- Will reduce draughts
- Will assist with noise reduction
- Available for 10mm or 12mm thick glass
- Self adhesive
- Silver anodised finish with grey woolpile
- Profile designed to match DS180 edge seal
- Available with different woolpile lengths
- Supplied in 3000mm lengths

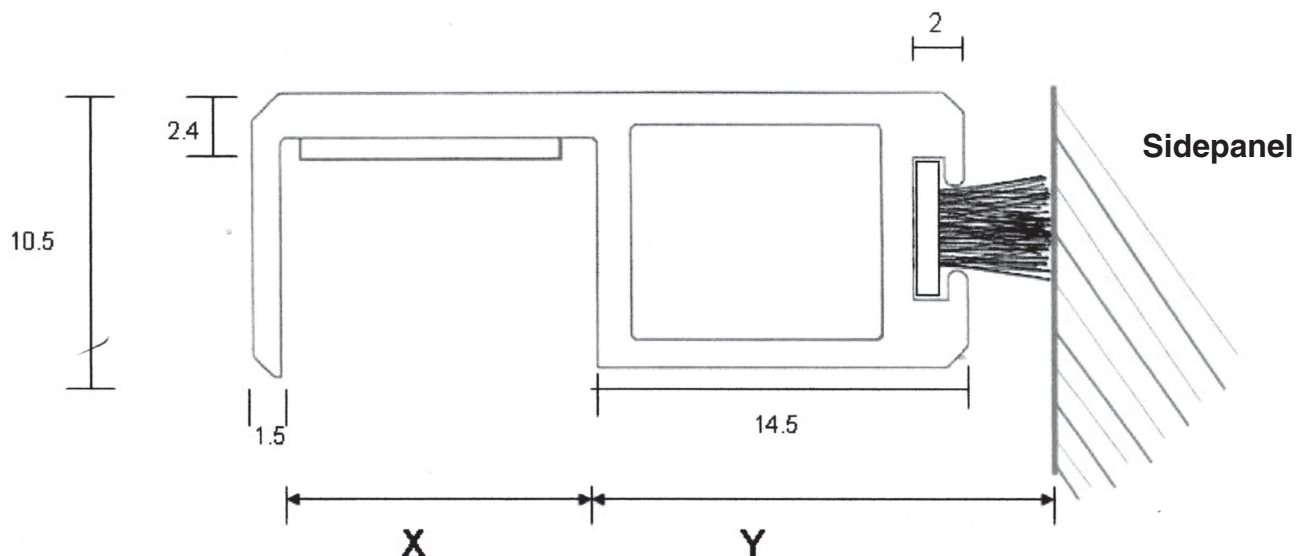

FRAMELESS COMMERCIAL HARDWARE

Channel Sections

PRICES PER LENGTH

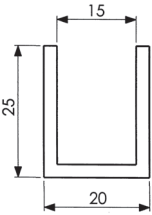
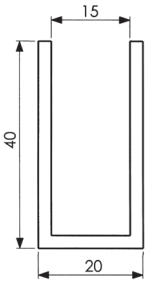
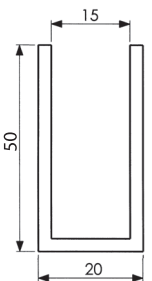
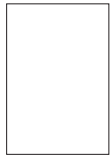
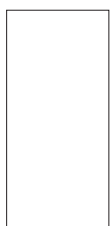
Product	Code	Description	Natural Silver Anodised	Mill Finish	Matt Black
	CS25	CHANNEL SECTION 25 X 20mm Stock lengths 3000mm 5000mm			
		3000mm	Bright Silver Anodised		
	CS40	CHANNEL SECTION 40 X 20mm Stock lengths 3000mm 5000mm			
		3000mm	Bright Silver Anodised		
	CS50	CHANNEL SECTION 50 X 20mm Stock length 5000mm			
			PRICE EACH		
	EC25	END CAP For CS25 Channel Natural silver anodised			
	EC40	END CAP For CS40 Channel Natural silver anodised			

FRAMELESS COMMERCIAL HARDWARE



Channel Section

For heavy weight toughened and laminated glass 10mm to 15mm.
Anodised to 20 microns. Available in stock lengths only.

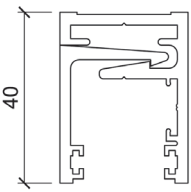
PRICES PER LENGTH

Product	Code	Description	Natural Silver Anodised	Mill Finish
	CS234	TWO PIECE CHANNEL SECTION 40mm x 30mm Stock length 5000mm		
	CS134	ONE PIECE CHANNEL SECTION 40mm x 30mm Stock length 5000mm		

Glazing Backing Seal

Product	Code	Description	PRICE PER METRE
	BS-2	2mm compressed	
	BS-4	4mm compressed	
			PRICE EACH
	34-EC	CHANNEL END CAP 40 x 30mm	

FRAMELESS COMMERCIAL HARDWARE

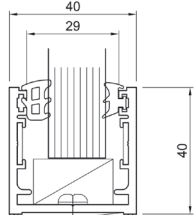

Channel Section

For heavy weight toughened glass & double glazed units from 18mm to 25mm.
Anodised to 20 microns. Available in stock lengths only.

Product	Code	Description	PRICES PER LENGTH	
			Natural Silver Anodised	Mill Finish
	CS244	TWO PIECE CHANNEL SECTION 40mm x 40mm Stock length 5000mm		
	CS144	ONE PIECE CHANNEL SECTION 40mm x 40mm Stock length 5000mm		
	44-EC	CHANNEL END CAP 40 x 40mm		

Channel Section

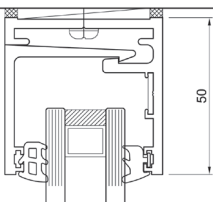
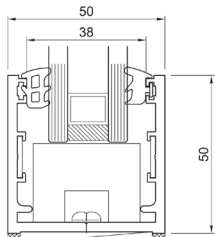
For double glazed units from 27mm to 34mm.
Anodised to 20 microns. Available in stock lengths only.

Product	Code	Description	PRICES PER LENGTH	
			Natural Silver Anodised	Mill Finish
	CS255	TWO PIECE CHANNEL SECTION 50mm x 50mm Stock length 5000mm		
	CS155	ONE PIECE CHANNEL SECTION 50mm x 50mm Stock length 5000mm		
	55-EC	CHANNEL END CAP 50 x 50mm		