

SECTION 1: SHOWER COMPONENTS

INDEX

Product	Page
Elite Hinges	1.1 - 1.2
Sliding Shower Doorkit	1.3
Handles	1.4
Knobs and Overpanel Clamps	1.5
Glass Shelves	1.6
Channels and End Caps	1.7
P.V.C. Shower Seals	1.8
Indicator Locks for Pivot Doors	1.9
Indicator Locks for Sliding Doors	1.10
Shelf Clamps and Brackets	1.11
Product Setout Details	
Elite Hinge Cutout Details	1.12

SHOWER COMPONENTS

Elite Hinges

Specify 8mm or 10mm glass thickness

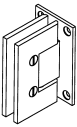
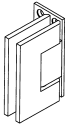
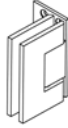
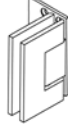
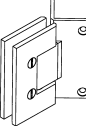
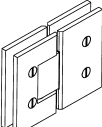
Product	Code	Description	Polished Chrome	Satin Chrome	Matt Black Powdercoat	Satin Nickel
	MF1	WALL FIX HINGE Standard mounting plate				
	MF1-L	WALL FIX HINGE Single sided mounting plate 37mm wide back plate 4 screw wall fixing				
	MF1-L3	WALL FIX HINGE Single sided mounting plate 50mm wide back plate 3 screw wall fixing				
	MF1-XL	WALL FIX HINGE Single sided mounting plate 62mm wide back plate 4 screw wall fixing				
	MF1-90	WALL FIX HINGE 90° mounting plate				
	MF2	GLASS TO GLASS FIX HINGE				

For glass cutout and hinge details refer page 1.12

Ensure all areas of side panel and door where hinges will clamp the glass are clean before installation.
Use IPA or Methylated Spirits for cleaning if needed.

SHOWER COMPONENTS

Elite Hinges

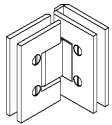
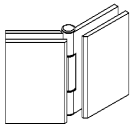
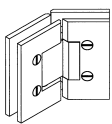
Product	Code	Description	Polished Chrome	Satin Chrome	Matt Black Powdercoat	Satin Nickel
	MF2-90	GLASS TO GLASS FIX HINGE 90° angle				
	MF2-BF	GLASS TO GLASS BIFOLD HINGE 180° angle				
	MF2-135	GLASS TO GLASS FIX HINGE 135° angle				

For hinge cutout and hinge details refer page 1.12

SHOWER COMPONENTS



Ozone Sliding Shower Doorkit

Suits 8mm or 10mm glass thickness.

For doors up to 45kg in weight.

Each set contains: Track, Track fixing bracket, Hangers, Anti jump buttons, Side panel fixing brackets, Wheels, Stops & Guide.

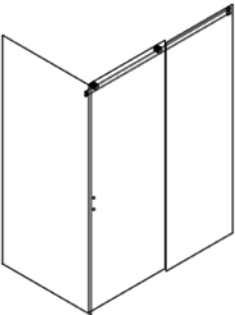

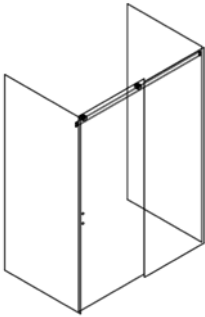
Finish: Bright Polished Stainless Steel.

Product	Code	Description	Price
	OTR-2000	GLASS TO WALL FIXING SET For showers up to 2000mm OA width	
	OTR-2000	WALL TO WALL FIXING SET For showers up to 2000mm OA width	
	OTR-2000	GLASS TO GLASS FIXING SET For showers up to 2000mm OA width	
	OTR-2000B	Additional button supports for OTR-2000 SHOWER	

Kits are sent out with all components to make any configuration above. Excluding channel and handle.



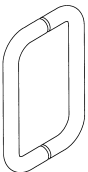
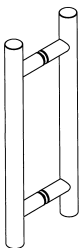
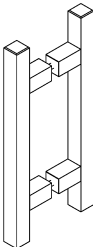

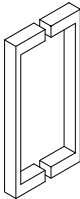
SHOWER COMPONENTS

Glasstech Stainless Steel Handles

Product	Code	Description	PSS	SSS	Matt Black Powdercoat	Satin Nickel
	G.T-250	D PULL HANDLE 25mm diameter Stainless Steel 250mm hole centres 12mm hole diameter				
	G.T-FR150	FINELINE ROUND PULL HANDLE 19mm diameter Stainless Steel 250mm long x 150mm hole centres 10mm hole diameter				
	G.T-FR250	FINELINE ROUND PULL HANDLE 25mm diameter Stainless Steel 350mm long x 250mm hole centres 10mm hole diameter				
	G.T-FS150	FINELINE SQUARE PULL HANDLE 19mm x 19mm square section Stainless Steel 250mm long x 150mm hole centres 10mm hole diameter				
	G.T-FS250	FINELINE SQUARE PULL HANDLE 19mm x 19mm square section Stainless Steel 350mm long x 250mm hole centres 10mm hole diameter				
	G.T-RA250	RECTANGULAR PULL HANDLE 20mm x 40mm rectangle section Stainless Steel 270mm long x 250mm hole centres 10mm hole diameter				
	G.T-Q250	RECTANGULAR PULL HANDLE 10mm x 20mm rectangle section Stainless Steel 270mm long x 250mm hole centres 10mm hole diameter				

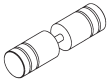
SHOWER COMPONENTS

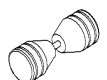
Plated Brass Knobs and Components

Product	Code	Description	Polished Chrome	Satin Chrome	PSS	SSS
	MK25	PULL KNOB SET 25mm diameter 10mm diameter hole				
	MK38	PULL KNOB SET 38mm diameter 10mm diameter hole				
	MK60	PULL KNOB SET 38mm diameter 10mm diameter hole				
	MKS25	PULL KNOB SET SQUARE 25 x 25mm square 10mm diameter hole				

Square Pull Handles

Product	Code	Description	Polished Chrome	Satin Chrome	Matt Black Powdercoat	
	MK70	SQUARE DOUBLE PULL HANDLE 70 x 50 x 24mm				

Over Panel Clamp

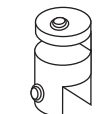
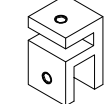
Product	Code	Description	Polished Chrome	Matt Black
	H05598	SHOWER OVERPANEL CLAMP – ROUND To suit 10mm shower to 6mm overpanel Chrome plate. 20mm diameter round profile		
	H05598S	SHOWER OVERPANEL CLAMP – SQUARE To suit 10mm shower to 6mm overpanel Chrome plate. 20mm x 20mm square profile		

SHOWER COMPONENTS



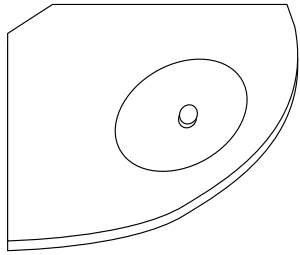
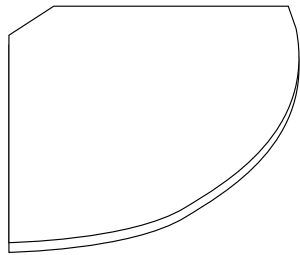
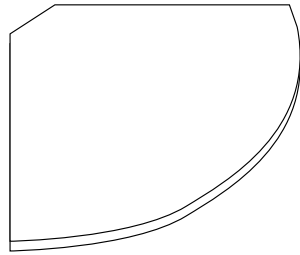
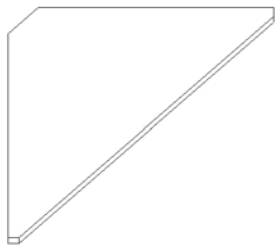



Glass Shelves

Product	Code	Description	Price
	GS200SD	CORNER SHELF WITH SOAP DISH 200 x 200 x 10mm Low iron toughened glass	
	GS250SD	CORNER SHELF WITH SOAP DISH 250 x 250 x 10mm Low iron toughened glass	
	GS200	CORNER SHELF 200 x 200 x 10mm Clear toughened glass	
	GS200/S	CORNER SHELF 200 x 200 x 10mm Low iron toughened glass	
	GS250	CORNER SHELF 250 x 250 x 10mm Clear toughened glass	
	GS250/S	CORNER SHELF 250 x 250 x 10mm Low iron toughened glass	
	GSA200	ANGLED CORNER SHELF 200 x 200 x 10mm Clear toughened glass	
	GSA250	ANGLED CORNER SHELF 250 x 250 x 10mm Clear toughened glass	

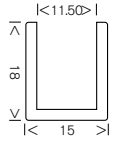
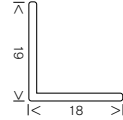
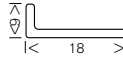
SHOWER COMPONENTS

Channels and End Caps

Prices per length

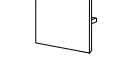
Product	Code	Description	Bright Silver Anodised	Natural Silver Anodised	Matt Black Powdercoat
	CS18	CHANNEL SECTION 19 x 18 2100mm 3000mm			
	CS15	CHANNEL SECTION 18 x 15 2100mm 3000mm			
	AS18	ANGLE SECTION 19 x 18 2500mm			
	AS6	ANGLE SECTION 6 x 18 Water Bar 1400mm 2800mm			
	HR1	HALF ROUND Water Bar 1400mm 2800mm			
	WD1	WATER DEFLECTOR Complete with felt 1400mm 2800mm			
	WD1-0	WATER DEFLECTOR Without felt 1400mm 2800mm			
	CC18	CHANNEL END CAP To suit CS18 channel			
	CC45	CHANNEL END CAP To suit 45° mitre CS18 channel			
	CC15	CHANNEL END CAP To suit CS15 channel			

SHOWER COMPONENTS

PVC Shower Seals

Prices per length

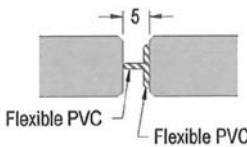
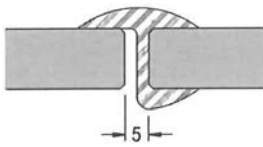
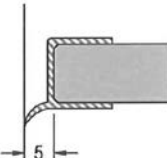
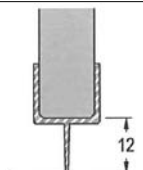
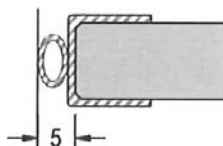
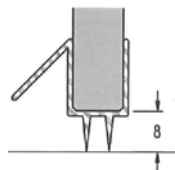
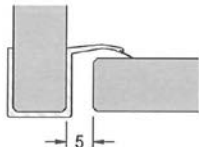
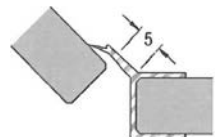
Product	Code	Description	
	MT 1	CLEAR WATER SEAL PVC rigid back and flexible seal to suit 10mm glass Length 2000mm	
	MWS 10-1	CLEAR WATER SEAL PVC rigid stop to suit 10mm glass Length 2200mm	
	MWS 10-5	CLEAR WATER SEAL PVC rigid channel and flexible fin to suit 10mm glass Length 2200mm	
	MWS 10-6	CLEAR WATER SEAL PVC rigid channel and flexible seal to suit 10mm glass Length 2200mm	
	MWS 10-7	CLEAR WATER SEAL PVC rigid channel and flexible tube seal to suit 10mm glass. Length 2200mm	
	MWS 10-10	CLEAR WATER SEAL PVC rigid channel / water deflector and dual flexible seals to suit 10mm glass. Length 2200mm	
	MWS 10-8	CLEAR WATER SEAL PVC rigid channel with flexible seal at 90° to suit 10mm glass. Length 2200mm	
	MWS 10-9	CLEAR WATER SEAL PVC rigid channel with flexible seal at 135° to suit 10mm glass. Length 2200mm	

NOTE: Clearances shown for water seals are only a guide

FRAMELESS GLASS SHOWER COMPONENTS

Glass Door Indicator Locks for Swing Doors

For Toilet and Bathroom Doors. To suit 8mm and 10mm glass.

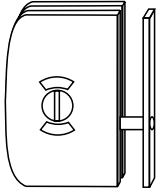
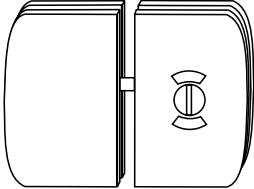
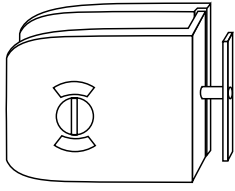
Product	Code	Description	Polished Chrome	Satin Chrome
	IL700C	INDICATOR LOCK Door to Wall (Glass cut out required)		
	IL701C	INDICATOR LOCK Door to Sidepanel (Glass cut out required)		
	IL600C	INDICATOR LOCK Door to Wall (No glass cut out required)		

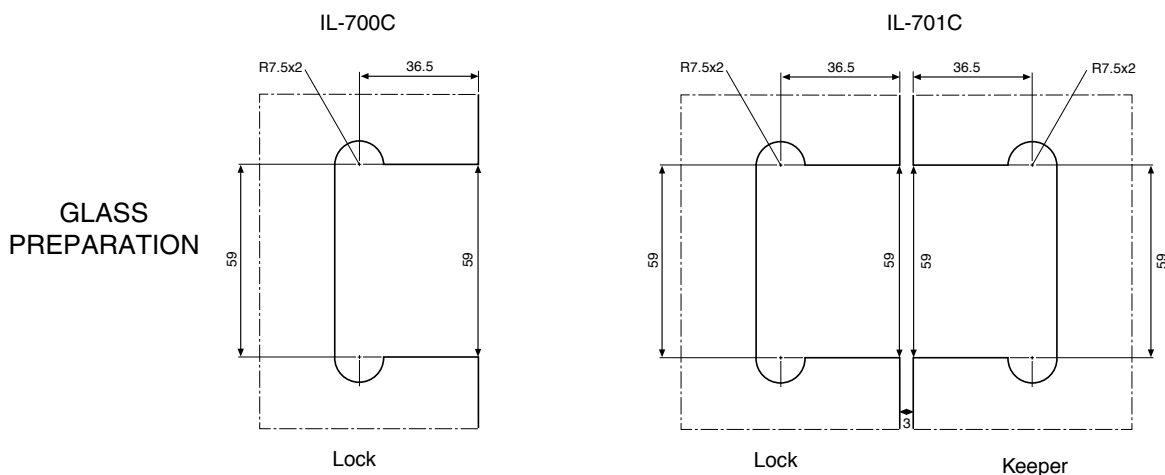

FRAMELESS GLASS SHOWER COMPONENTS

Glass Door Indicator Locks for Sliding Doors

For Toilet and Bathroom Doors. To suit 8mm and 10mm glass.

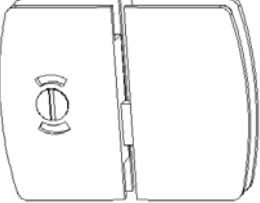
Product	Code	Description	Polished Chrome	Satin Chrome
	IL700C-H	INDICATOR LOCK Door to Wall (Glass cut out required)		
	IL701C-H	INDICATOR LOCK Door to Sidepanel (Glass cut out required)		

GLASS
PREPARATION

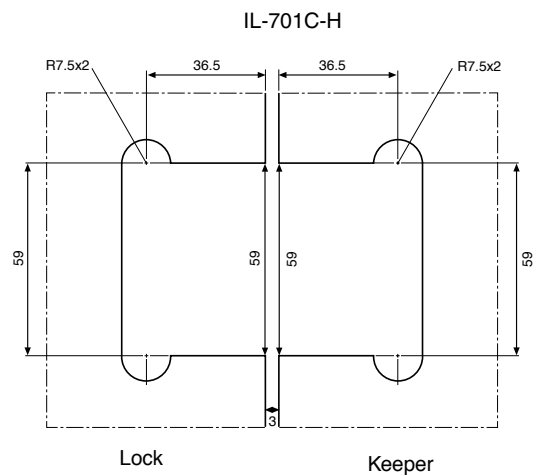
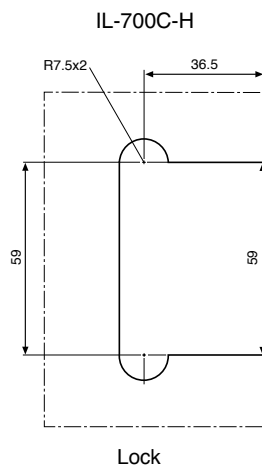

SHOWER COMPONENTS

Glass Clamps

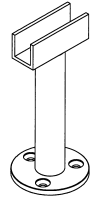
Product	Code	Description	Polished Chrome	Satin Chrome
	MB6	SHELF BRACKET for 6mm shelf		
	MB8	SHELF BRACKET for 8mm shelf		
	MB10	SHELF BRACKET for 10mm shelf		
	MB12	SHELF BRACKET for 12mm shelf		
	MV100	UPSTAND SUPPORT BRACKET 100mm high		

ELITE SHOWER HINGES

**MF1
WALL MOUNT
HINGE**

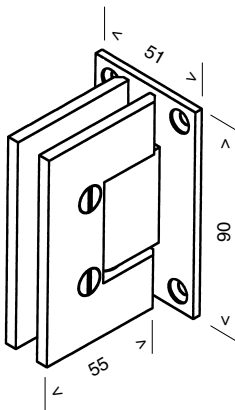

**MF1-L
SINGLE SIDE WALL
MOUNT HINGE**

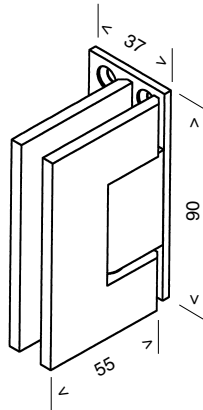

**MF1-90
WALL MOUNT HINGE
90° FIXING**

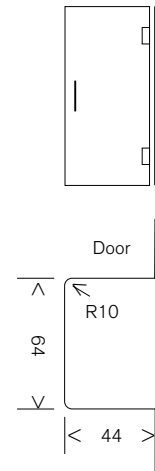
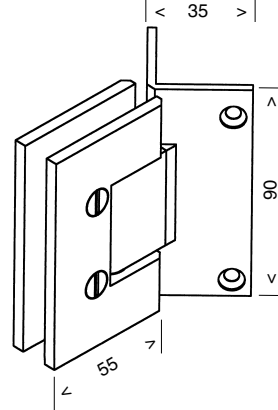

**MF2
GLASS TO GLASS HINGE**

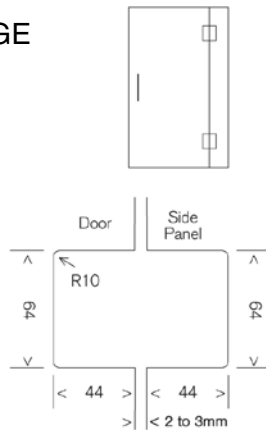
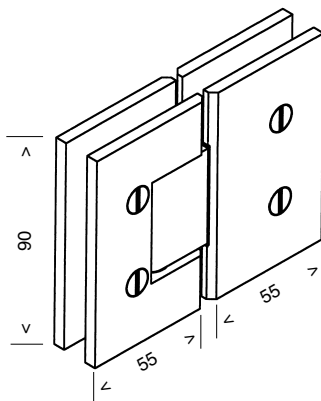

**MF2-135
GLASS TO GLASS 135° HINGE**

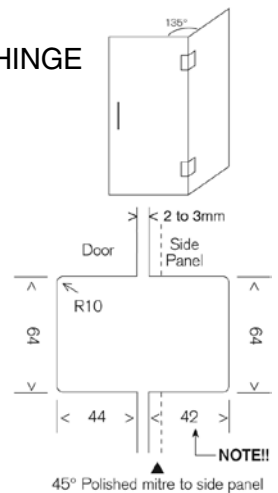
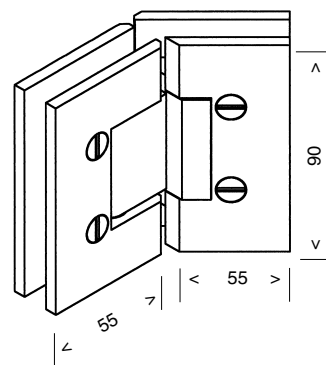

**MF2-90
GLASS TO GLASS 90° HINGE**

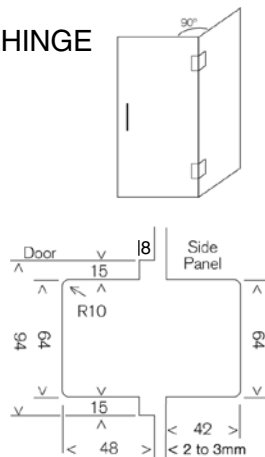
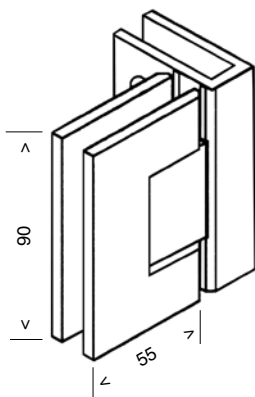

**MF2-BF
GLASS TO GLASS
BIFOLD HINGE**

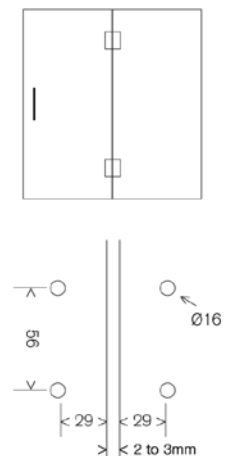
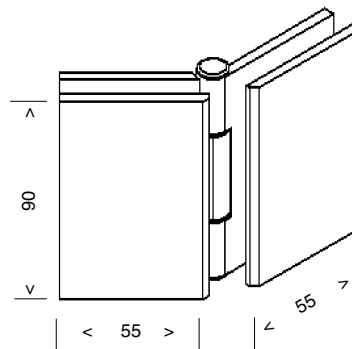

Maximum door weight is 35kg and maximum door width is 800mm for above hinges.