

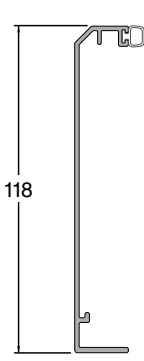

SECTION 5: FRAMELESS BALUSTRADE SYSTEMS	INDEX
Product	Page
Infinity Balustrade Face Fix	5.1 - 5.3
Infinity Balustrade Top Fix	5.4 - 5.5
Infinity Fixings	5.6
Powder Coat Standard Colour Range	5.7
<hr/>	
Aluminium Link Rail for 12mm and 15mm Glass	5.8 - 5.10
Stainless 40mm Link Rail for 12mm to 21.5mm Glass	5.11
Stainless 425mm Link Rail for 12mm Glass	5.12
Panel Clamps up to 12mm Glass	5.13
Balustrade Panel Clamps for 12mm to 21.5mm Glass	5.14
<hr/>	
PosiGlaze Balustrade	5.15 - 5.17
50mm Diameter Disc Fittings	5.18
50mm Disc Fitting Components and Fixings	5.19 - 5.20
75mm Disc Fittings	5.21
75mm Disc Fixings	5.22
JH165 Face Fix Clamp	5.23
JH165 Face Fix Clamp Fixings	5.24
<hr/>	
Aluminium Mini Post Face Fix	5.25
Aluminium Mini Post Top Fix Concealed Fixing	5.26
Aluminium Mini Post Top Fix Exposed Fixings	5.27
Aluminium Mini Post Fixings	5.28
SP155 Top Fix Mini Post	5.29
<hr/>	
Handrail Brackets	5.30 - 5.31
<hr/>	
Pool Gate Hinges Laguna	5.32 - 5.33
Pool Gate Hinges Malibu	5.34 - 5.35
Pool Gate Latches	5.36 - 5.37

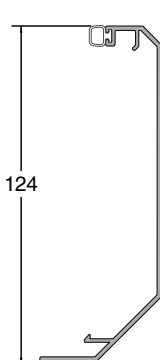

FRAMELESS BALUSTRADE SYSTEMS

Infinity Balustrade Face Fix Components

Product	Code	Description	Price
	IB-IC	INNER COVER – With bulb seal IB-IC-N-5000 Natural anodised IB-IC-N-2500 Natural anodised	Length
		IB-IC-M-5000 Mill aluminium IB-IC-M-2500 Mill aluminium	
		IB-IC-P-5000 Powder coat IB-IC-P-2500 Powder coat All powder coat colours are to order. Orders under 20 lineal metres will have short run surcharge. Non standard colours in the Juralco range will have a surcharge. P.O.A.	
	IB-OC	STANDARD OUTER COVER – With bulb seal IB-OC-N-5000 Natural anodised IB-OC-N-2500 Natural anodised	
		IB-OC-M-5000 Mill aluminium IB-OC-M-2500 Mill aluminium	
		IB-OC-P-5000 Powder coat IB-OC-P-2500 Powder coat All powder coat colours are to order. Orders under 20 lineal metres will have a short run surcharge. Non standard colours in the Juralco range will have a surcharge. P.O.A.	
	IB-FOC	FLAT OUTER COVER – With bulb seal IB-FOC-N-5000 Natural anodised IB-FOC-N-2500 Natural anodised	
		IB-FOC-M-5000 Mill aluminium IB-FOC-M-2500 Mill aluminium	
		IB-FOC-P-5000 Powder coat IB-FOC-P-2500 Powder coat All powder coat colours are to order. Orders under 20 lineal metres will have a short run PLC surcharge. For standard powder coat colours see page 5.7.	

FRAMELESS BALUSTRADE SYSTEMS

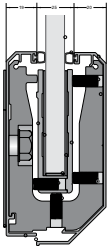
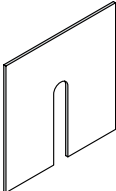
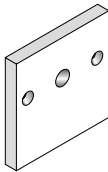
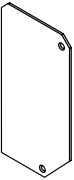
Infinity Balustrade Face Fix Components

Product	Code	Description	Price Each
	IB-CB12 IB-CB15 IBCB-17	CLAMP KIT – For 12mm and 13.52 glass CLAMP KIT – For 15mm glass CLAMP KIT – For 17.52mm glass	
	IB-SP-1	INNER COVER SPACER – 1mm thick IB-SP-1-SF Silver frost IB-SP-1-M Mill aluminium IB-SP-1-PC Powder coat	
	IB-SP-5	INNER COVER SPACER – 5mm thick IB-SP-5-SF Silver frost IB-SP-5-M Mill aluminium IB-SP-5-PC Powder coat	
	IB-SP-15	INNER COVER SPACER – 15mm thick IB-SP-15-SF Silver frost IB-SP-15-M Mill aluminium IB-SP-15-PC Powder coat	
	IB-EC	STANDARD OUTER COVER END CAP IB-EC-N Natural anodised IB-EC-M Mill aluminium IB-EC-PC Powder coat	
	IB-ECF	FLAT OUTER COVER END CAP IB-ECP-N Natural anodised IB-ECP-M Mill aluminium IB-ECP-PC Powder coat	

For standard power coat colours refer to page 5.7

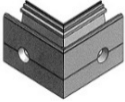
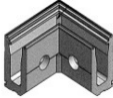

FRAMELESS BALUSTRADE SYSTEMS

Infinity Balustrade Face Fix Components

Product	Code	Description	Price Each
	IB-EX	IB-EX-CORNER External corner block to support outer covers Matt black finish	
	IB-IN	IB-IN-CORNER Block to support outer covers Matt black finish	

FRAMELESS BALUSTRADE SYSTEMS

Infinity Balustrade Top Fix

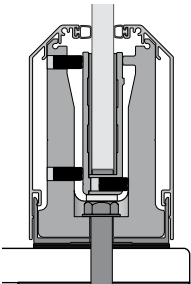
Product	Code	Description	Price
	IBT-BC	BASE PLATE SECTION to ensure alignment of clamps IBT-BC-N-5000 Natural Anodised IBT-BC-N-2500 Natural Anodised	
		IBT-BC-M-5000 Mill aluminium IBT-BC-M-2500 Mill aluminium	
		IBT-BC-P-5000 Powder coat IBT-BC-P-2500 Powder coat All powder coat colours are to order. Orders under 20 lineal metres will have a short run surcharge. Non standard colours in the Juralco range will have a surcharge P.O.A.	
	IBT-OC	OUTER COVER PLATES WITH BULB SEAL Cover plates required each side of clamps IBT-OC-N-5000 Natural anodised IBT-OC-N-2500 Natural anodised	
		IBT-OC-M-5000 Mill aluminium IBT-OC-M-2500 Mill aluminium	
		IBT-OC-P-5000 Powder coat IBT-OC-P-2500 Powder coat All powder coat colours are to order. Orders under 20 lineal metres will have a short run surcharge. Non standard colours in the Juralco range will have a surcharge P.O.A.	
	IBT-C12 IBT-C15 IBT-C17	TOP FIX CLAMPS Clamp kit for 12mm and 13.52mm glass Clamp kit for 15mm glass Clamp kit for 17.52mm glass	Each

For standard power coat colours refer to page 5.7

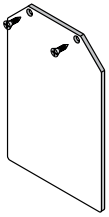
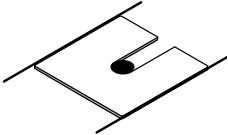

FRAMELESS BALUSTRADE SYSTEMS

Infinity Balustrade Top Fix

Product	Code	Description	Price
	IBT-EC	TOP FIX END CAPS End cap with screw fixings IBT-EC-N Natural anodised	
		IBT-EC-M Mill aluminium	
		IBT-EC-P Powder coat	
	IBT-SP	BASE PLATE PACKERS To align clamps if floor uneven Pack at clamp positions IBT-SP1-SF 1mm packer in Silver frost IBT-SP5-SF 5mm packer in Silver frost Silver frost is to match Natural anodised finish	
		IBT-SP1-M 1mm packer in Mill aluminium IBT-SP5-M 5mm packer in Mill aluminium	
		IBT-SP1-PC 1mm packer in Powder coat IBT-SP5-PC 5mm packer in Powder coat	

FRAMELESS BALUSTRADE SYSTEMS

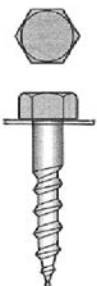
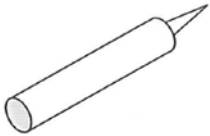
Infinity Balustrade Fixings





Product	Code	Description	Price
		TYPICAL TIMBER FIXINGS	
	WF12-120	M12 x 120mm COACH SCREW & WASHER Stainless steel For face fix installation When not using 15mm spacer	
	WF12-130	M12 x 130mm COACH SCREW & WASHER Stainless steel For face fix installation When not using 15mm spacer	
	WF12-160	M12 x 160mm COACH SCREW & WASHER Stainless steel For top fix installation	
	SIKA-SG	SIKA SUPERGRIP CARTRIDGE For all bonding of all wood fixings	
	FIS-V	FISCHER FIS-V 300T MASONRY ANCHOR FIX CARTRIDGE For bonding of rods into concrete	
		TYPICAL CONCRETE FIXINGS	
	MF12-140	M12 x 140mm THREADED ROD, HEX NUT & WASHER Stainless steel For face fix & top fix installations	
	TF12-120	M12 x 120mm LAG SCREW, HEX NUT & WASHER Stainless steel For extra high wind zone pool fence only (Face fix)	

FRAMELESS BALUSTRADE SYSTEMS



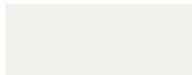
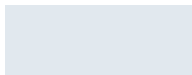
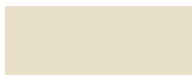



STANDARD POWDER COAT COLOURS



WHITE

	MATT APPLIANCE WHITE 9151274M
	ARCTIC WHITE 91558851
	OFF WHITE 91558804
	PEARL WHITE 28897434
	MATT RIVERGUM BEIGE 9153143M
	MATT WOODWIND 9153155M

BROWN

	MATT BRONCO 9152111M
	MATT DESERT SAND 9153065M
	MATT IRONSAND 9158096M
	MATT KAURI 9158159M
	MATT LIGNITE 9158033M
	MATT OLIVE 9156193M

BLUE

	MATT NEW DENIM BLUE 9155063M
--	--





GREEN

	MATT KARAKA 9156064M
	MATT LICHEN 9156101M
	MATT MIST GREEN 9156103M
	MATT PERMANENT GREEN 9156102M







LIGHT GREY

	MATT CANVAS CLOTH 9157327M
	MATT GHOST GREY 9157401M
	MATT GULL GREY 9157511M
	MATT O'KEEFE GREY 9157400M
	LSG MATT TITANIA 9152068M

METROPOLIS (KINETIC)

	BRONZE FROST KINETIC 9008194K
	SILVER FROST KINETIC 9157323K
	SILVER PEARL METROPOLIS KINETIC 9157113K
	SILVER STAR METROPOLIS KINETIC 9157043K
	WINDOW BRONZE METROPOLIS KINETIC 9158068K

BLACK

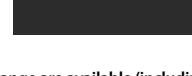
	MATT BLACK 9159041M
	MATT CHARCOAL 9159058M
	MATT FLAX POD 9159145M
	MATT GRAVEL 9157404M
	MATT GREY FRIARS 9157167M
	MATT SANDSTONE GREY 9157217M
	SATIN BLACK 91558651

RED

	MATT SCORIA 9154114M
---	--------------------------------

ANOTEC

	ANOTEC MID BRONZE 91558751
---	--------------------------------------

Other powder coat colours from the Interpon Standard, Dulux Duralloy or Dulux Metropolis Pearls Powder coat range are available (including Satin rather than Matt Finishes), however please note that they incur a surcharge. Please contact Juralco with any queries.

These colours are representative only, please take the time to check an actual powder coated sample of the colour of your choice

FRAMELESS BALUSTRADE SYSTEMS

Aluminium Link Rail for 12mm and 15mm Toughened Glass

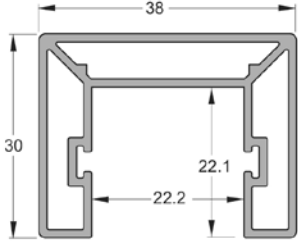
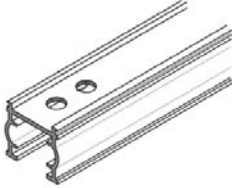
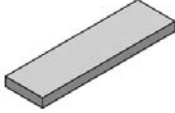
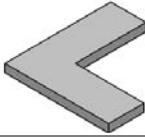
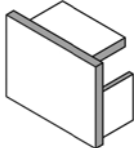
Product	Code	Description	Price
		ALUMINIUM LINK RAIL 38 x 30	
	ET220-5.8-N	5800mm Natural anodised	
	ET220-2.9-N	2900mm Natural anodised	
	ET220-5.8-M	5800mm Mill aluminium	
	ET220-2.9-M	2900mm Mill aluminium	
	ET220-5.8-P	5800mm Powder coat	
	ET220-2.9-P	2900mm Powder coat *Powder coat terms as per below	
	ETG12/2.9	2900mm LINK RAIL GASKET To suit 12mm glass	
	ETG15/2.9	2900mm LINK RAIL GASKET To suit 15mm glass	
	ET30	180° STRAIGHT JOINER	
	ET31	90° CORNER JOINER	
	ET37-N ET37-M ET37-P	END CAP Natural anodised END CAP Mill aluminium END CAP Powder coat	

NOTE: All powder coat colours are to order. Orders under 20 lineal metres will have a short run surcharge. Non standard colours in the Juralco range will have a surcharge P.O.A. For standard colour range see page 5.7.

FRAMELESS BALUSTRADE SYSTEMS



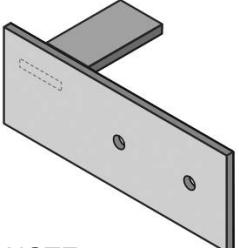
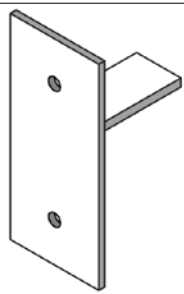
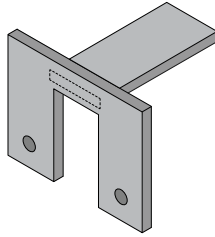

Aluminium Link Rail Components

Product	Code	Description	Price
 <p>NOTE: Image is Left hand</p>		WALL MOUNT END PLATES	
	ET40-LH-N	Silver Frost P.C. to match Natural anodised	
	ET40-RH-N	Silver Frost P.C. to match Natural anodised	
	ET40-LH-M	Mill stainless steel	
	ET40-RH-M	Mill stainless steel	
	ET40-LH-P	Powder coat	
	ET40-RH-P	Powder coat	
		SOLID POST AND WALL MOUNT END PLATES	
	ET38-N	Silver Frost P.C. to match Natural anodised	
	ET38-M	Mill stainless steel	
	ET38-P	Powder coat	
		POST MOUNT END PLATES	
	ET42-N	Silver Frost P.C. to match Natural anodised	
	ET42-M	Mill stainless steel	
	ET42-P	Powder coat	

NOTE: All powder coat colours are to order. Orders under 20 lineal metres will have a short run surcharge. Non standard colours in the Juralco range will have a surcharge P.O.A. For standard colour range see page 5.7.

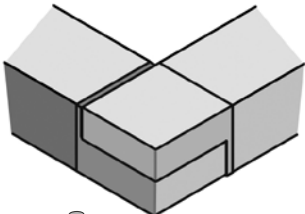

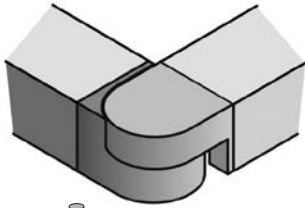

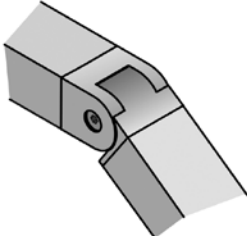
FRAMELESS BALUSTRADE SYSTEMS

Aluminium Link Rail Components

Product	Code	Description	Price
  M6 x 25 C/S SS machine screw		TWO PIECE 90° CORNER CONNECTOR	
	ET45-N	Silver Frost P.C. to match Natural anodised	
	ET45-M	Mill Aluminium	
	ET45-P	Powder coat	
  M6 x 25 C/S SS machine screw		TWO PIECE ADJUSTABLE CORNER CONNECTOR 180° TO 90°	
	ET46-P	Silver Frost P.C. to match Natural anodised	
	ET46-M	Mill Aluminium finish	
	ET46-P	Powder coat	
		TWO PIECE ADJUSTABLE STAIRWAY CONNECTOR	
	ET47-P	Silver Frost P.C. to match Natural anodised	
	ET47-M	Mill Aluminium	
	ET47-P	Powder coat	

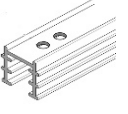



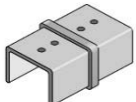
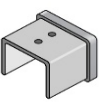
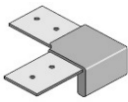
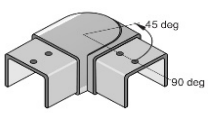
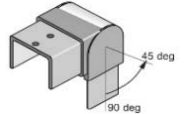

FRAMELESS BALUSTRADE SYSTEMS

40mm Polished Stainless Link Rail for 12-21.5mm Glass

Product	Code	Description		Price
	ET/430/5.8/PSS	PSS	PSS 316L INTERLINKING TOP RAIL 40mm x 30mm 5800mm	
	ET/430GT/12/2.9	Black	PSS INTERLINKING TOP RAIL 12mm Gasket 2900mm	
	ET/430GT/15/2.9	Black	PSS INTERLINKING TOP RAIL 15mm Gasket 2900mm	
	ET436/PSS	PSS	PSS 2205 WALL BRACKET	
	ET437/RH/PSS	PSS	PSS 2205 WALL BRACKET RIGHT HAND	
	ET437/LH/PSS	PSS	PSS 2205 WALL BRACKET LEFT HAND	
	ET431/PSS	PSS	PSS 2205 INTERLINKING RAIL 180° INLINE JOINER	
	ET432/PSS	PSS	PSS 2205 INTERLINKING END CAP	
	ET433/PSS	PSS	PSS 2205 INTERLINKING 90° JOINER	
	ET434/PSS	PSS	PSS 2205 INTERLINKING RAIL 90 - 45° HORIZONTAL JOINER	
	ET435/PSS	PSS	PSS 2205 INTERLINKING RAIL 90 - 45° VERTICAL JOINER	

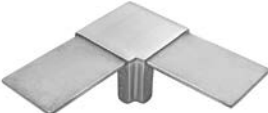

FRAMELESS BALUSTRADE SYSTEMS

Link Rail S25 Railing System for 12mm Glass 2205 Satin Stainless

Product	Code	Description	Price
	S25LR	LINKRAIL 2205 SSS 25mm x 21mm Stock length 5800mm	per 5800mm stock length
	S25WB-LH	WALL MOUNT BRACKET Left hand shown	
	S25WB-RH	WALL MOUNT BRACKET Right hand	
	S25AJ	ADJUSTABLE JOINER 2205 SSS To suit S25 LR Link Rail	
	S25AHJ	ADJUSTABLE HORIZONTAL JOINER To suit S25 LR Link Rail 2205 SSS	
	S2590C	FIXED 90° CORNER CONNECTOR 2205 SSS To suit S25 LR Link Rail	
	S25IJ	INLINE JOINER 2205 SSS To suit S25 LR Link Rail	
	S25EC	END CAP 2205 SSS To suit S25 LR Link Rail	

FRAMELESS BALUSTRADE SYSTEMS

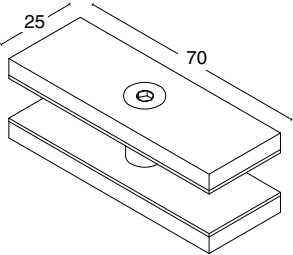
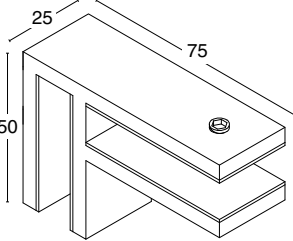
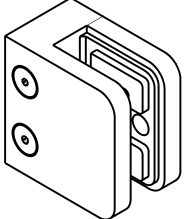
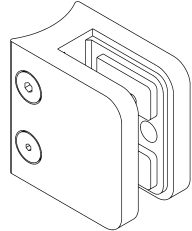
Panel Clamp up to 12mm thick

Product	Code	Description	Price
	BC25-180	BALUSTRADE PANEL CLAMP 180° Will help align & stiffen 12mm Balustrade Panels No holes required 316SSS	
	BC25-90	BALUSTRADE PANEL CLAMP 90° Will help align & stiffen 12mm Balustrade Panels External screws. No holes required 316SSS	
	SS200	SATIN STAINLESS STEEL GLASS CLAMP No glass preparation required 35kg per clamp loading 316 stainless steel Specify glass thickness to be clamped 8mm, 10mm, 12mm	
	SS201	SATIN STAINLESS STEEL GLASS CLAMP No glass preparation required Radius back to suit 50mm diameter post 35kg per clamp loading 316 stainless steel Specify glass thickness to be clamped 8mm, 10mm, 12mm	
	SP202	SECURITY PIN can be fitted into SS200 x SS201 clamps	
	Cap - 37w	WOOD FIX CAP SCREW 14G x 37mm SS WOOD FIX CAP SCREW 14G x 50mm SS	
	Cap - 25T	METAL THREAD CAP SCREW M8 x 25mm	

FRAMELESS BALUSTRADE SYSTEMS

Balustrade Glass Clamps for 12-21.5mm Glass

Can be used with toughened laminate instead of a Link Rail

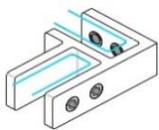
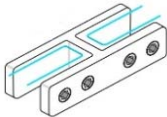
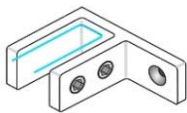
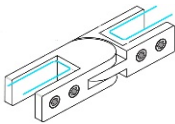
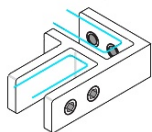
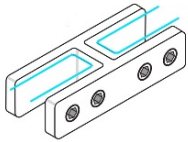
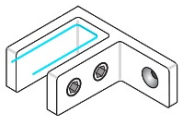
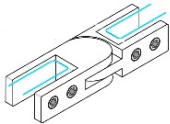
Product	Code	Description	Price
	JET70/PSS	PSS EDGETEC 90° 12-15.5mm GLASS CLAMP 2205 Stainless	
	JET70/SSS	SSS	
	JET71/PSS	PSS EDGETEC 180° 12-15.5mm GLASS CLAMP 2205 Stainless	
	JET71/SSS	SSS	
	JET72/PSS	PSS EDGETEC WALL FIX 90° 12-15.5mm GLASS CLAMP 2205 Stainless	
	JET72/SSS	SSS	
	JET73/PSS	PSS EDGETEC 90-180° ADJUSTABLE 12-15.5mm GLASS CLAMP 2205 Stainless	
	JET73/SSS	SSS	
	JET80/PSS	PSS EDGETEC 90° 17.2-21.52mm GLASS CLAMP 2205 Stainless	
	JET80/SSS	SSS	
	JET81/PSS	PSS EDGETEC 180° 17.2-21.52mm GLASS CLAMP 2205 Stainless	
	JET81/SSS	SSS	
	JET82/PSS	PSS EDGETEC WALL FIX 90° 17.2-21.52mm GLASS CLAMP 2205 Stainless	
	JET82/SSS	SSS	
	JET83/PSS	PSS EDGETEC 90-180° ADJUSTABLE 17.2-21.52mm GLASS CLAMP 2205 Stainless	
	JET83/SSS	SSS	

FRAMELESS BALUSTRADE SYSTEMS

PosiGlaze Glass Balustrade System

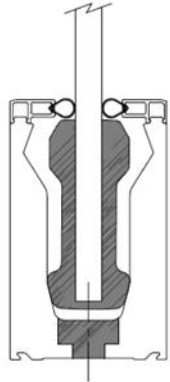
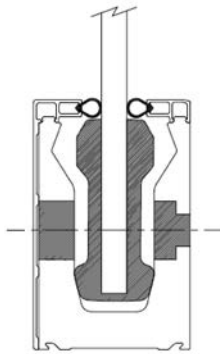
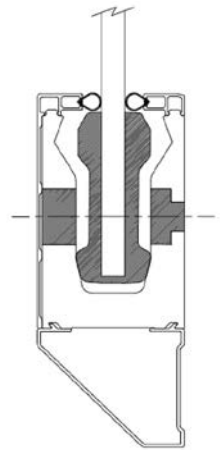

Product	Code	Description	Price per Length
	PG120B	POSIGLAZE BASE FIX SYSTEM Complete with seal strips, gaskets and glass clamps. Stock length: 3000mm Material: Aluminium Finish: Satin Stainless Effect	
	PG120BM	Finish: Mill. including 2 side cladding covers *Supplied in 3 metre kits *Specify glass thickness when ordering	
	PG120S	POSIGLAZE FACE FIX SYSTEM Complete with seal strips, gaskets, side cladding and glass clamps. Stock length: 3000mm Material: Aluminium Finish: Satin Stainless Effect	
	PG120SM	Finish: Mill *Supplied in 3metre kits *Specify glass thickness when ordering.	
	PG180S	POSIGLAZE FACE FIX SYSTEM Complete with seal strips, gaskets, side cladding, bottom cladding and glass clamps. Stock length: 3000mm Material: Aluminium Finish: Satin Stainless Effect	
	PG180SM	Finish: Mill *Supplied in 3metre kits *Specify glass thickness when ordering	

*Powdercoat P.O.A

For protection against a fall, refer building code and / or any proprietary design document.

FRAMELESS BALUSTRADE SYSTEMS

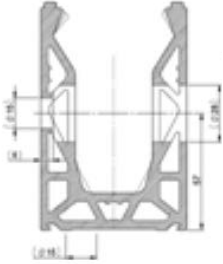

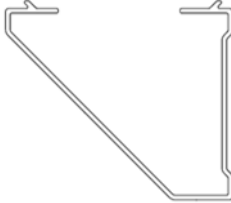



PosiGlaze Glass Balustrade System Components

Product	Code	Description	Price per Length
	PGBC	BASE FIX CHANNEL Stock length: 3000mm	
	PGSC	FACE FIX CHANNEL Stock length: 3000mm	
	PGTS	TOP SEAL STRIP Stock length: 3000mm	
	PGTSM	Mill Finish Stock length: 3000mm	
	PGSCL	SIDE CLADDING Stock length: 3000mm	
	PGSCLM	Mill Finish Stock length: 3000mm	
	PGBCL	BOTTOM CLADDING Stock length: 3000mm	
	PGBCLM	Mill Finish Stock length: 3000mm	

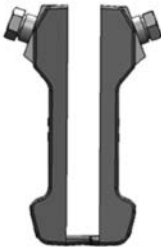
*Powdercoat P.O.A

FRAMELESS BALUSTRADE SYSTEMS

PosiGlaze Glass Balustrade System Components

Product	Code	Description	Price
	PGC12 PGC15 PGC19 PGC13 PGC17 PGC21	Glass Clamp - to suit 12mm Glass Clamp - to suit 15mm Glass Clamp - to suit 19mm Glass Clamp - to suit 13.5mm Glass Clamp - to suit 17.5mm Glass Clamp - to suit 21.5mm (each kit contains 12 clamps)	per clamp
	PGCD	Channel Joiners	per pair
	PGEC PGEC1 PGECL PGECL	End Caps - Base Fix (suit PG120B) End Caps - Face Fix (suit PG120S) End Caps - Face Fix LH (suit PG180S) End Caps - Face Fix RH (suit PG180S)	per cap
	PGECM PGEC1M PGECLM PGECLM	End Caps - Base Fix (suit PG120B) End Caps - Face Fix (suit PG120S) End Caps - Face Fix LH (suit PG180S) End Caps - Face Fix RH (suit PG180S)	per cap
	PGSPN	Spanners	each
	PGBS	Bulb Seal (specify glass thickness to suit)	per metre

FRAMELESS BALUSTRADE SYSTEMS

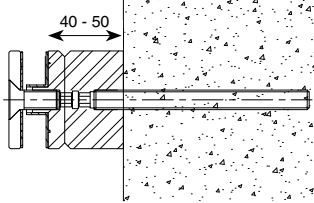
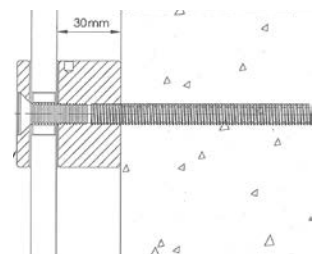
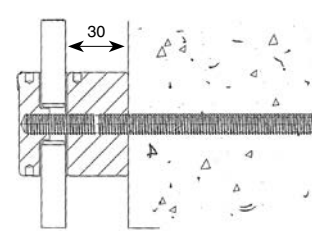
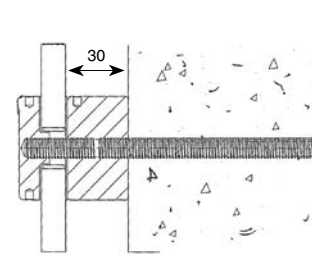
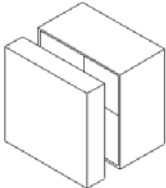

50mm Face Fix Disc Fittings

Specify glass thickness / Glass Hole 25mm

Product	Code	Description	Price
	MB50/A/T45	HEAVYWEIGHT ANCHOR 316SSS 50mm diameter with square edge head Adjustable standoff 40mm to 50mm MB50/A/T45 in 316SSS	
	ET50/S30	HEAVYWEIGHT ANCHOR 316SSS 50mm diameter with square edge head 30mm standoff Specify glass thickness ET/530/SSS in 316 satin stainless ET/530/PSS in 316 polished stainless	
	ET50/T30	HEAVYWEIGHT ANCHOR 316SSS 50mm diameter button head 30mm standoff Specify glass thickness ET/T30/SSS in 316 satin stainless ET/T30/PSS in 316 polished stainless	
	ET50/T30/PC	POWDER COATED ALUMINIUM WITH STEPPED DISC HEAD Powder coated to order Specify glass thickness For standard powder coat colours see page 5.7	
	MB50/SQ	SQUARE COVER KIT to convert MB50/S/T30 and SD50X30 Round fixings to square sets 316SSS	

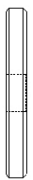
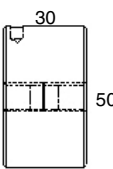
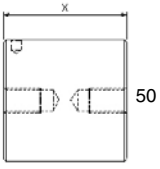
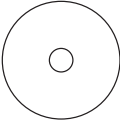
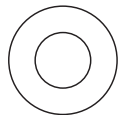

FRAMELESS BALUSTRADE SYSTEMS

50mm Disc Components

Product	Code	Description	Price
	ET50/CSK	50mm Dia x 6mm CSK Disc M10 316 SSS	
	SD50-B	50mm Dia Stepped Disc 10mm thick head 316 SSS	
	ET50/6/S	50mm Dia x 6mm Spacer with Clearance hole for M10 Rod 316 SSS	
	MB50-B30	50mm Dia x 30mm Body M10 316 SSS	
	MB50-BX	50mm Dia Special Length Body Specify X. X = length 316 SSS	
	FG-50	50mm Dia x 0.8mm Black Fibre Gasket	
	NB-20	19.5mm Dia Nylon Bush to suit M10 & M12 Rod	

FRAMELESS BALUSTRADE SYSTEMS

50mm Disc Fittings

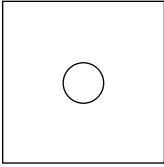
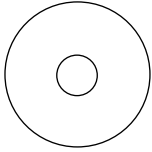
Product	Code	Description	Price
	M10-R50R M10-R130R	STAINLESS STEEL RODS M10 x 50mm M10 x 130mm	
	M10-100SL M10-120SL	STAINLESS STEEL LAG SCREW M10 x 100mm M10 x 120mm	
	M10-HN M10-DN	M10 HEX NUT SS M10 DOME NUT SS	
	M10-30 M10-5HR	WASHERS M10 x 30mm Dia 2.5mm SS M10 SPRING WASHER SS	
	M10-SQ	FLAT SQUARE WASHER 50 x 50 x 3 SS	
	FG-50	FIBRE GASKET 50mm Dia 0.8mm thick Black For internal or external applications	

FRAMELESS BALUSTRADE SYSTEMS

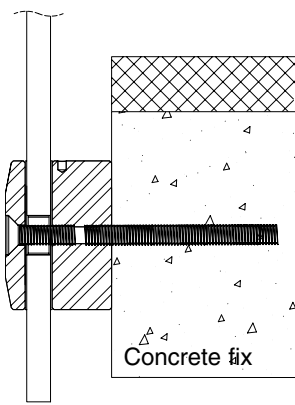
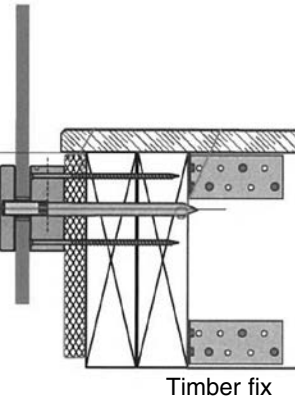

75mm Face Fix Single Disc Fittings

Specify glass thickness

Product	Code	Description	Price
 <p>Concrete fix</p>	JET75/S/T30	<p>HEAVYWEIGHT SINGLE DISC 75mm diameter disc Suitable for single line installations 30mm Standoff Finish 316SSS Suitable for 12mm & 15mm toughened glass Specify glass thickness Suitable for fixing to timber concrete or steel Glass hole 25mm</p>	
 <p>Timber fix</p>	JET75/T30-P	<p>HEAVYWEIGHT SINGLE DISC 75mm diameter disc Suitable for single line installations 30mm Standoff Hidden fixing head Powder coated aluminium Suitable for 12mm & 15mm toughened glass Suitable for fixing to timber concrete or steel Made of aluminium and powder coated customers specification</p> <p>All powder coat colours are to order Minimum order 15 units If less a short run surcharge will apply Non standard colours from the Juralco range will incur a surcharge. P.O.A. For standard powder coat colours refer to page 5.7</p>	

FRAMELESS BALUSTRADE SYSTEMS

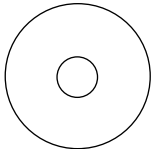
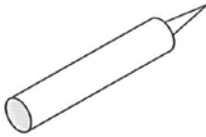

75mm Face Fix Single Disc Fixings

Product	Code	Description	Price
	M12-120L	STAINLESS STEEL LAG SCREW M12 X 120mm for timber fixing To be used in conjunction with 3 x BB-125 Bugle screws per disc fitting	
	BS-125	STAINLESS STEEL BUGLE SCREWS 14G X 125mm to be used in conjunction with the above lag screw for timber fixing	
	M12X180R	STAINLESS STEEL THREADED ROD M12 X 180mm for concrete fixing	
	FG-75	FIBRE GASKET 75mm Dia 0.8mm thick Black	
	SIKA-SG	SIKA SUPERGRIP CARTRIDGE For all bonding of all wood fixings	
	FIS-V	FISCHER FIS-V 300T MASONRY ANCHOR FIX CARTRIDGE For bonding of rods into concrete	

FRAMELESS BALUSTRADE SYSTEMS

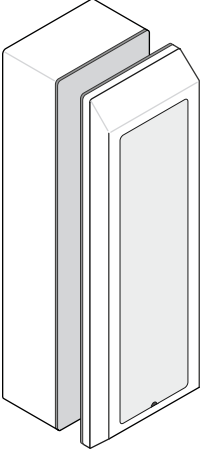

JH165 Face Fix Clamps

For installation details request the JH clamp technical brochure

Product	Code	Description	Price
	JH165	<p>CLAMP FIXING WITH DOUBLE POINT FIXING to the structure 30mm stand off Aluminium construction Powder coated to customers specification</p> <p>All powder coat colours are to order Minimum order 15 units If less a short run surcharge will apply Non standard colours from the Juralco range will incur a surcharge. P.O.A. Non standard colours from the Juralco range will incur a surcharge. P.O.A.</p>	
	JH165-BKT	<p>HIDDEN FIXING ANGLE BRACKET These brackets are fitted to the JH clamp to allow the fixing decking timber to conceal the JH clamps</p> <p>Powder coating terms as per above For standard powder coat colours refer to page 5.7</p>	

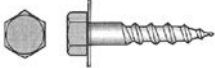
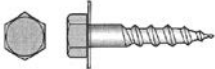

FRAMELESS BALUSTRADE SYSTEMS

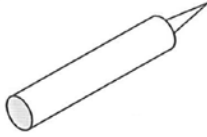
JH165 Face Fix Clamps

Product	Code	Description	Price
	WF10-130	M10 x 130mm COACH SCREW & WASHER Stainless steel For fixing into double joists Two fixings per JH165 clamp	
	WF10-170	M10 x 170mm COACH SCREW & WASHER Stainless steel For fixing into triple joists Two fixings per JH165 clamp	
	MF10-130	M10 x 130mm THREADED ROD, HEX NUT & WASHER Stainless steel Concrete fixing Two fixings per JH165 clamp	
	SIKA-SG	SIKA SUPERGRIP CARTRIDGE For all bonding of all wood fixings	
	FIS-V	FISCHER FIS-V 300T MASONRY ANCHOR FIX CARTRIDGE For bonding of rods into concrete	

FRAMELESS BALUSTRADE SYSTEMS

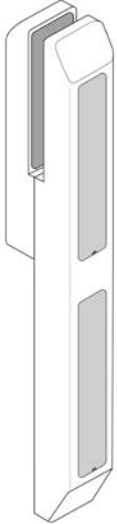



Aluminium Mini Post Face Fix

Product	Code	Description	Price
		To suit 12mm toughened glass Suitable for domestic C3 balustrades and pool fences 400mm long	
	MPF-S	Post in Silver Frost P/C	
	MPF-P	Powder coat colour to order If less than six posts a powder coat surcharge will apply Non standard colours from the Juralco range will have a surcharge. P.O.A.	
	MF10-130	CONCRETE FIXING M10 x 130 threaded rod, hex nut & washer SS	
	WF10-130	TIMBER FIXING M10 x 130 Coach Screw & Washer SS	

NOTE: For standard powder coat colours see page 5.7.

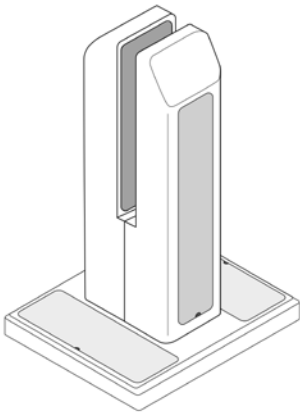
FRAMELESS BALUSTRADE SYSTEMS

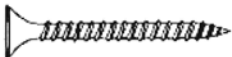
Aluminium Mini Post Top Fix Concealed Fixing

Product	Code	Description	Price
		To suit 12mm toughened glass Suitable for domestic C3 balustrades and pool fences	
	MPT-CS	Post in Silver Frost Finish P/C	
	MPT-CP	Powder coat colour to order If less than six posts a powder coat surcharge will apply Non standard colours from the Juralco range will have a surcharge. P.O.A.	
	CSM-120	Masonry Fixing CSK Sleeve Anchor for masonry fixing M10 x 120mm SS	
	CSW-120	Timber Fixing M10 x 120 CSK coach screw SS	
	SF-30	Steel Fixing CSK machine screw for threading into steel structure M10 x 30 SS	

NOTE: For standard powder coat colours see page 5.7.

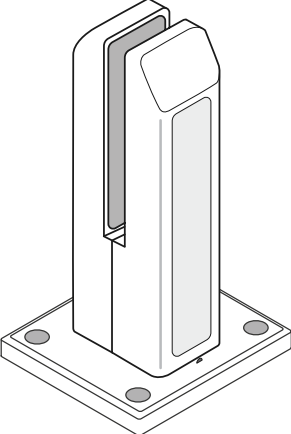
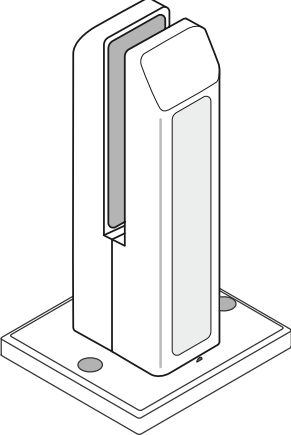
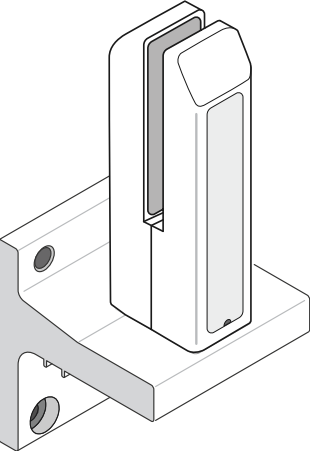

FRAMELESS BALUSTRADE SYSTEMS

Aluminium Mini Post Top Fix Exposed Fixing

Product	Code	Description	Price
		To suit 12mm toughened glass Suitable for domestic C3 balustrades and pool fences	
	MPT-W	MINI POST with standard JET 300 base plate for timber fixing Requires 4 x M10 coach screws see page 5.28	
	MPT-M	MINI POST with standard JE301 base plate for concrete or steel fixing Requires 2 x M12 fixings see page 5.28	
	MPT-G	MINI POST with standard JET 137/65 Gutter bracket fixing Requires 4 x M10 fixings see page 5.28	
		Powder coat colour to order If less than six posts a powder coat surcharge will apply Non standard colours from the Juralco range will have a surcharge. P.O.A. NOTE: For standard powder coat colours see page 5.7.	

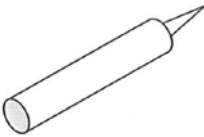

FRAMELESS BALUSTRADE SYSTEMS

Aluminium Mini Post Exposed Fixings

Product	Code	Description	Price
	WF10-130	M10 x 130mm COACH SCREW & WASHER 316 Stainless steel Suits JET300 and JET 137/65 Fixing plates for timber installations	
	WD10-130	M10 x 140mm LAG SCREW WITH FLAT WASHER & DOME NUT 316 Stainless steel Attractive wood fixing option for JET30 timber fixing	
	CF12-130	M12 x 130mm THREADED ROD, WASHER AND DOME NUT 316 Stainless steel Suits JET301 base plate For concrete fixing 316SS	
	SIKA-SG	SIKA SUPERGRIP CARTRIDGE For all bonding of all wood fixings	
	FIS-V	FISCHER FIS-V 300T MASONRY ANCHOR FIX CARTRIDGE For bonding of rods into concrete	

FRAMELESS BALUSTRADE SYSTEMS

SP155 Top Fix Mini Post

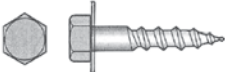
Product	Code	Description	Price
	SP155T	STRUT POST BASE FIX 2 point fixing to substrate 2205 duplex grade Satin Stainless Steel For 12mm toughened glass	
	MF10-130	THREADED ROD, FLAT WASHER & NUT Masonry Fix M10 x 115mm Stainless Steel	
	SF-40	HEX BOLT, FLAT WASHER & NUT Steel Fix M10 x 40mm Stainless Steel	
	WF10-180	STAINLESS STEEL COACH SCREW & HD FLAT WASHER Pool Fence only Wood Fix M10 x 180mm	

FRAMELESS BALUSTRADE SYSTEMS

Balustrade Handrail Bracket

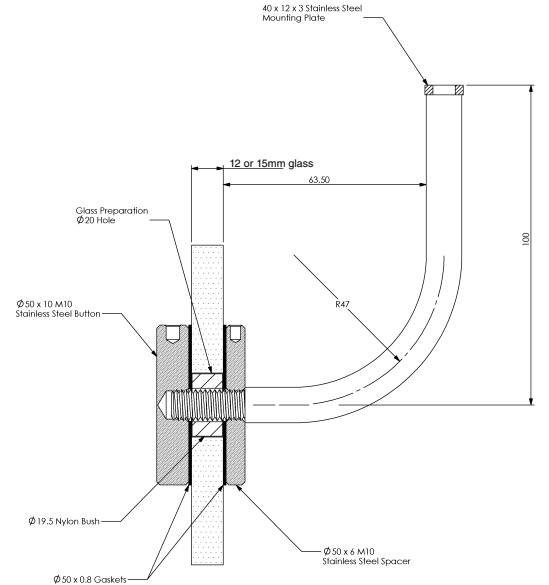
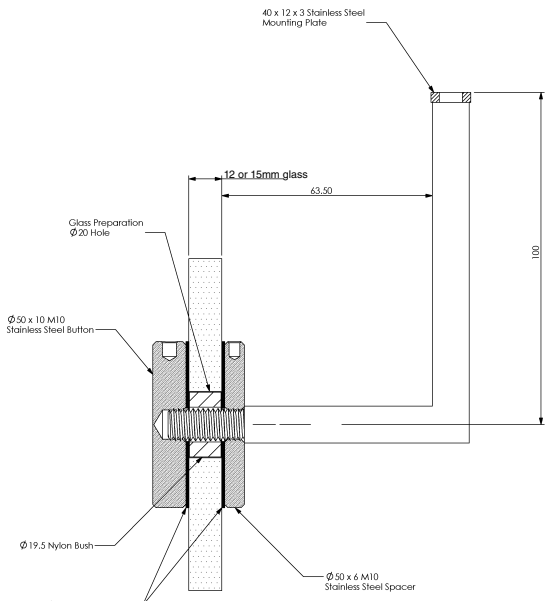
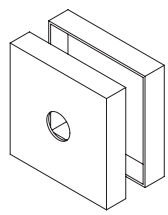
Product	Description	SSS
	<p>HB50/R/90°-12 HB50/R/90°-15 HANDRAIL BRACKET Round arm section Suitable for timber or stainless steel handrails. 316SSS</p> <p>Available as solid wall Fixing 3 x CSK SCREWS MOUNTING HB50/R/90-W</p>	
	<p>HB50/S/90°-12 HB50/S/90°-15 HANDRAIL BRACKET Square section arm Suitable for timber or stainless steel handrails. 316SSS</p> <p>Available as solid wall Fixing 3 X CSK SCREWS MOUNTING HB50/S/90-W</p>	
	<p>HB50/S/CK 50MM SQUARE COVER KIT To convert HB50 discs to square 316SSS</p>	

FRAMELESS BALUSTRADE SYSTEMS

Balustrade Handrail Bracket – Heavy Duty

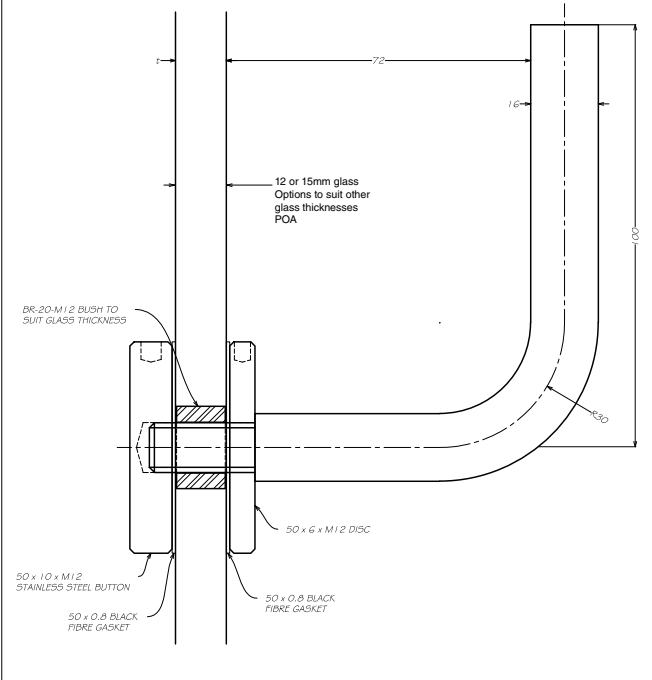
Product	Description	SSS
	<p>HB50/R/90°/HD12 HB50/R/90°/HD15 Handrail Bracket Suitable for stainless steel handrails. 316SSS</p>	

FRAMELESS BALUSTRADE SYSTEMS

Laguna High Strength Pool Gate Hinge

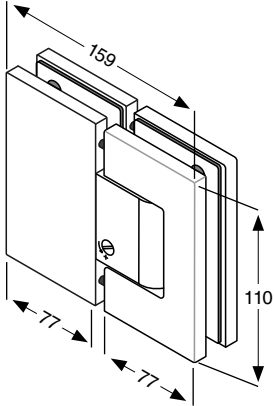
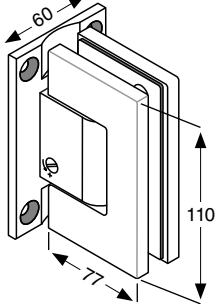
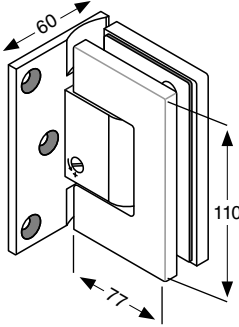
Product	Code	Description	Price Per Single Hinge	
		Pool gate hydraulic hinges with adjustable closing speed and adjustable closed position	316 SSS	316 PSS
	LH-180 NHO	Glass to Glass Non Hold Open Suits 10mm & 12mm Glass		
	Max gate width 1000mm Note: When hinging gates off glass side panels ensure panels are at least one and a half times the width of the gate or the side panel is fixed back to solid structure. When ordering specify SSS or PSS finish.			
	LH-90 NHO	Wall to Glass Non Hold Open Centered back plate. 60mm wide. Suits 10mm & 12mm Glass		
	Max gate width 1000mm			
	LH-90L NHO	Wall to Glass Non Hold Open Offset back plate. 60mm wide. Suits 10mm & 12mm Glass		
	Max gate width 1000mm			

For Glass cut out and hinge detail see page 5.32

FRAMELESS BALUSTRADE SYSTEMS

Laguna Hydraulic Gate Hinges: Cut Out & installation details

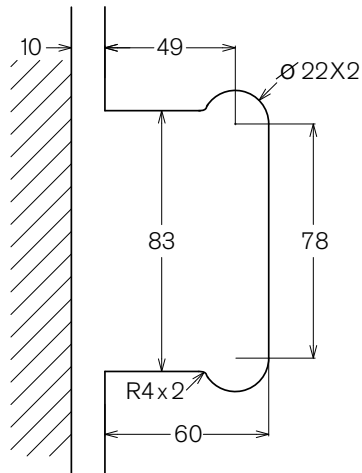

Wall to Glass Cut Out

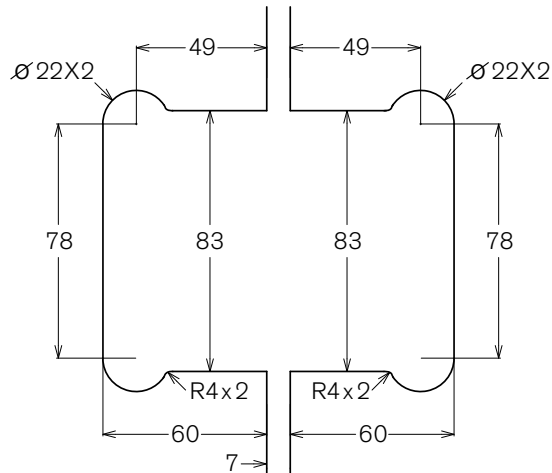

Glass to Glass Cut Out

Door alignment

1. Remove covers (E)
2. Loosen allen screws by 360° (D)
3. Adjust to required angle and retighten allen screws (D)
4. (C) is slotted speed valve.

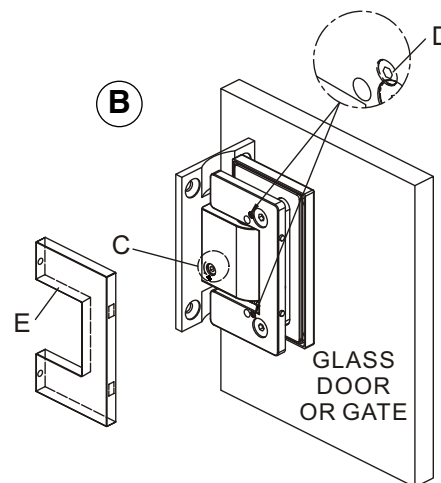
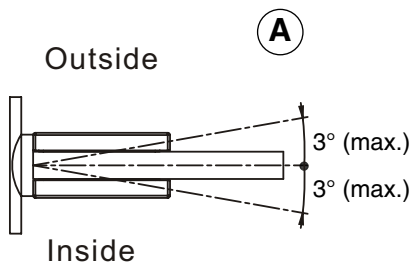

These self closing hydraulic gate hinges are designed to close gates up to 1000mm wide in external and in internal installations. They are designed to be used with the range of Malibu Latches for pool gates. Hinges are Non Hold Open. The hinges are available in both glass to glass and glass to post/wall models and both models are Non Handed, meaning they can be hung on either side of the gate opening.

Gaskets are provided so the glass gate and side panels can be 10mm or 12mm toughened glass.

1. Remove clip on covers and install the hinges. Ensure all clearances are correct.
2. If gate requires alignment, loosen allen keys on both hinges by 360° as per detail B. Set the door to correct alignment and retighten allen screws.
3. To set closing speed, close slotted screws on both hinges then open both ¼ of a turn. Then open or close slotted valves to obtain required closing speed. Take care to ensure the valves of each hinge are synchronized so they close at equal speed.
4. Install clip on covers.

FRAMELESS BALUSTRADE SYSTEMS

Malibu Hydraulic Pool Gate Hinges

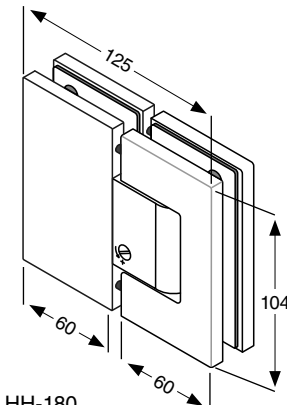
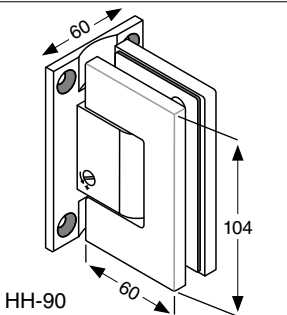
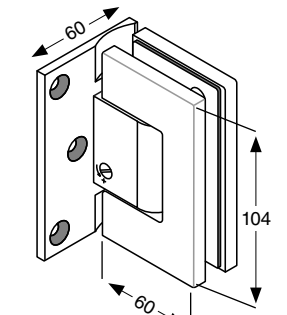
Product	Code	Description	Price Per Single Hinge	
 <p>HH-180</p>		Pool gate hydraulic hinges with adjustable closing speed and adjustable closed position	316 SSS	316 PSS
	HH-180 NHO	Glass to Glass Non Hold Open Suits 10mm & 12mm Glass		
	Max gate width 900mm			
 <p>HH-90</p>	HH-90 NHO	Wall to Glass Non Hold Open Centered back plate. 60mm wide. Suits 10mm & 12mm Glass		
	Max gate width 900mm			
 <p>HH 90-L</p>	HH-90L NHO	Wall to Glass Non Hold Open Offset back plate. 60mm wide. Suits 10mm & 12mm Glass		
	Max gate width 900mm			

For Glass cut out and hinge detail see page 5.34

FRAMELESS BALUSTRADE SYSTEMS

Malibu Hydraulic Gate Hinges: Cut Out & installation details

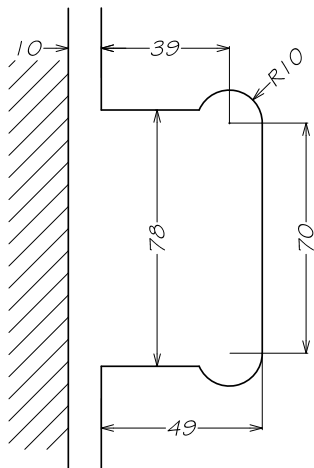

Wall to Glass Cut Out

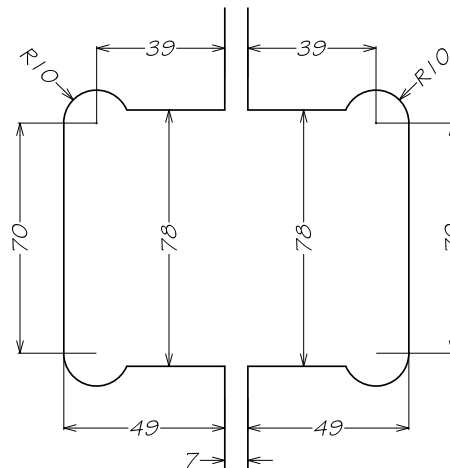

Glass to Glass Cut Out

Door alignment

1. Remove covers (E)
2. Loosen allen screws by 360° (D)
3. Adjust to required angle and retighten allen screws (D)
4. (C) is slotted speed valve.

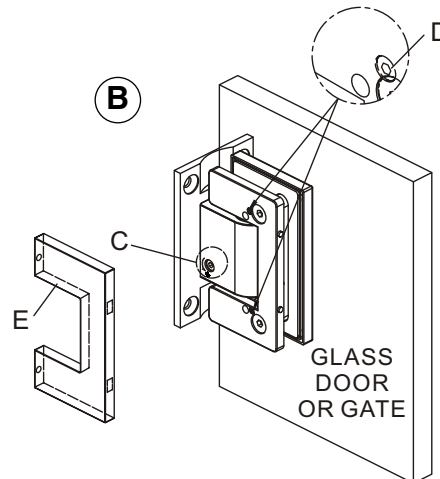
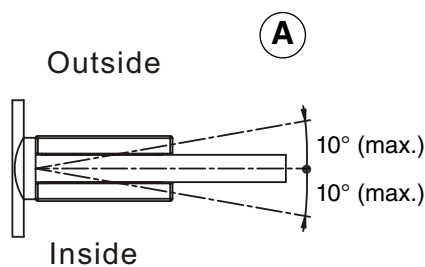

These self closing hydraulic gate hinges are designed to close gates up to 900mm wide in external and in internal installations. They are designed to be used with the range of Malibu Latches for pool gates. Hinges are Non Hold Open. The hinges are available in both glass to glass and glass to post/wall models and both models are Non Handed, meaning they can be hung on either side of the gate opening.

Gaskets are provided so the glass gate and side panels can be 10mm or 12mm toughened glass.

1. Remove clip on covers and install the hinges. Ensure all clearances are correct.
2. If door requires alignment, loosen allen keys on both hinges by 360° as per detail B. Set the door to correct alignment and retighten allen screws.
3. To set closing speed, close slotted screws on both hinges then open both ¼ of a turn. Then open or close slotted valves to obtain required closing speed. Take care to ensure the valves of each hinge are synchronized so they close at equal speed.
4. Install clip on covers.

FRAMELESS BALUSTRADE SYSTEMS

Malibu Pool Gate Latches

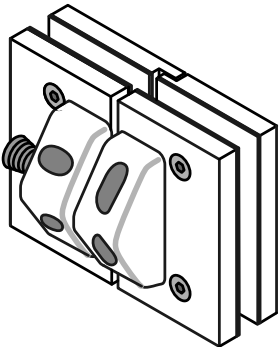
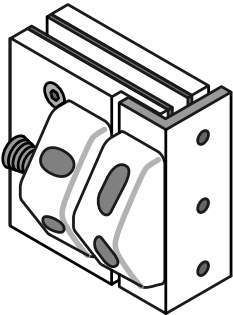
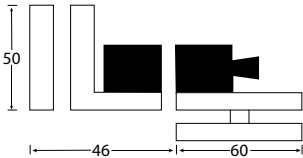
Product	Code	Description	Price
These latches are designed to match both the Malibu and Laguna series pool gate hinges.			316 SSS & 316 PSS
	MGL-SSS	GLASS TO GLASS POOL GATE LATCH Suits 10mm & 12mm glass Finish 316 SSS	
	MGL-PSS	GLASS TO GLASS POOL GATE LATCH Suits 10mm & 12mm glass Finish 316 PSS	
	MGL-P-SSS	GLASS TO POST OR WALL GATE LATCH Suits 10mm & 12mm glass Finish 316 SSS	
	MGL-P-PSS	GLASS TO POST OR WALL GATE LATCH Suits 10mm & 12mm glass Finish 316 PSS	
	MGL-90-SSS	90° GLASS TO GLASS LATCH Suits 10mm & 12mm glass Finish 316 SSS	
	MGL-90-PSS	90° GLASS TO GLASS LATCH Suits 10mm & 12mm glass Finish 316 PSS	

FRAMELESS BALUSTRADE SYSTEMS

Malibu Pool Gate Latch Preparation

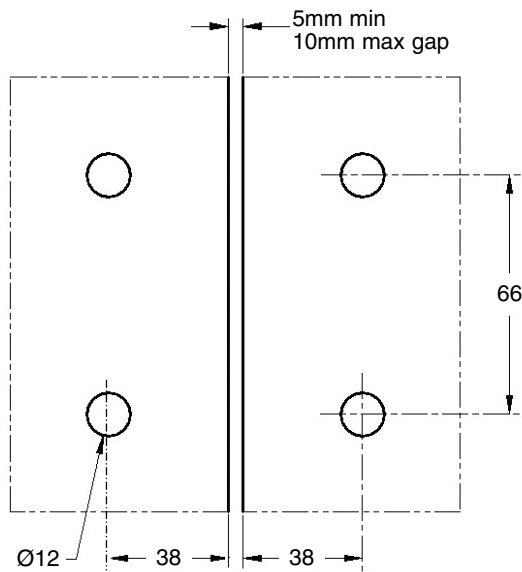

MGL – Glass to Glass

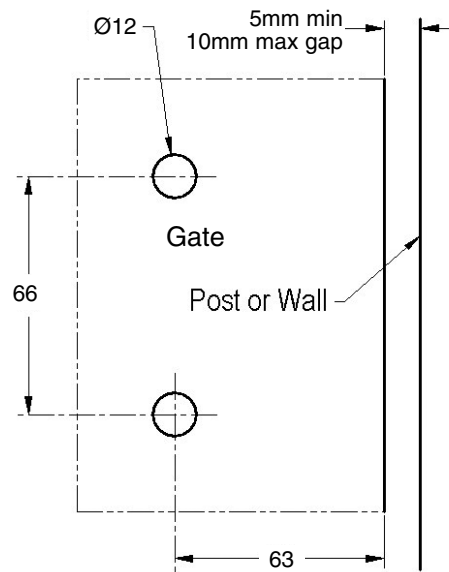

MGL-P – Wall to Post to Glass

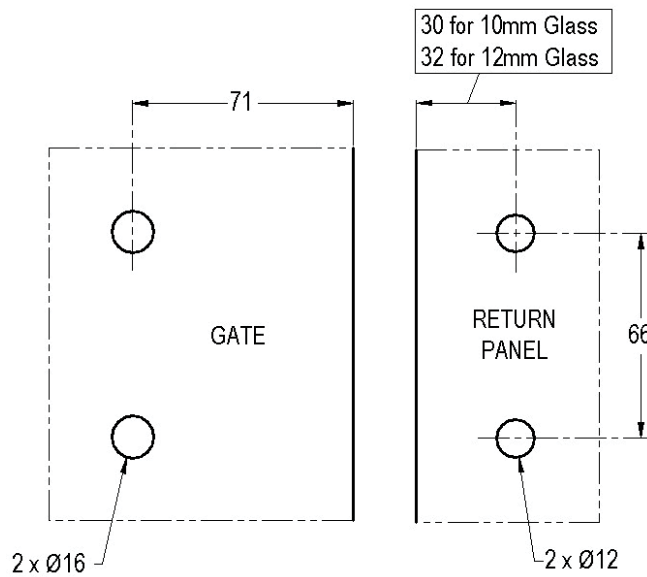

MGL-90